

## Serie 89000

 <b>89000</b> Pag. 8.7	 <b>89010</b> Pag. 8.7	 <b>89030</b> Pag. 8.7	 <b>89040</b> Pag. 8.8	 <b>89050</b> Pag. 8.8	<b>New</b>  <b>89055</b> Pag. 8.8	 <b>89106</b> Pag. 8.9	 <b>89111</b> Pag. 8.9	 <b>89116</b> Pag. 8.9	
 <b>89130</b> Pag. 8.10	 <b>89211</b> Pag. 8.10	 <b>89216</b> Pag. 8.10	 <b>89223</b> Pag. 8.11	 <b>89226</b> Pag. 8.11	 <b>89230</b> Pag. 8.11	 <b>89310</b> Pag. 8.12	 <b>89500</b> Pag. 8.12	 <b>88610</b> Pag. 8.12	
 <b>89700</b> Pag. 8.13	 <b>50980</b> Pag. 8.13	 <b>50990</b> Pag. 8.13	 <b>50006</b> Pag. 8.13						



**CARATTERISTICHE TECNICHE**  
 TECHNICAL CHARACTERISTICS  
 TECHNISCHE ANGABEN  
 CARACTÉRISTIQUES TECHNIQUES  
 CARACTERÍSTICAS TÉCNICAS  
 CARACTERÍSTICAS TÉCNICAS



**Norma di Riferimento**  
 Reference standard  
 Entspricht der Norm  
 Norme de référence  
 Normativa de referencia  
 Norma de referência

1907/2006  
**REACH** ✓

2011/65/CE  
**RoHS** ✓

PED  
 2014/68/UE

ISO  
 14743:2004

**SILICON  
 FREE**

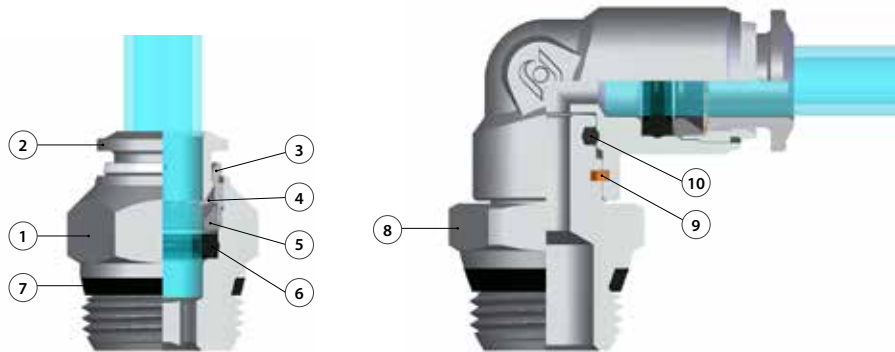

Materiali e Componenti	IT	Component Parts and Materials	GB	Komponenten und Materialien	DE
1 Corpo in ottone nichelato		1 Nickel-plated brass Body		1 Körper Messing vernickelt	
2 Spintore sgancio tubo in Ottone nichelato		2 Nickel-plated brass Collet		2 Rohr Lösering Messing vernickelt	
3 Capsula in ottone nichelato		3 Nickel-plated brass Capsule		3 Haltering Messing vernickelt	
4 Pinza d'aggraffaggio in acciaio inox AISI 301		4 Steel AISI 301 Clamping washer		4 Zahnscheibe Edelstahl AISI 301	
5 Anello di posizionamento in tecnopolimero		5 Technopolymeric positioning ring		5 Positioniering Technopolymer	
6 Guarnizione a labbro in NBR (FKM o EPDM a richiesta)		6 NBR molded seal (if requested FKM - EPDM)		6 Lippendichtung NBR (FKM - EPDM auf Anfrage)	
7 Guarnizione filetto in NBR (FKM o EPDM a richiesta)		7 NBR Thread packing (if requested FKM - EPDM)		7 Gewindeabdichtung NBR (FKM - EPDM auf Anfrage)	
8 Basetta Filettata in ottone nichelato		8 Base Threaded Nickel Plated Brass		8 Gewindebasis Messing vernickelt	
9 Seeger		9 Seeger		9 Seeger	
10 Guarnizione in NBR (FKM o EPDM a richiesta)		10 NBR molded seal (if requested FKM - EPDM)		10 Lippendichtung NBR (FKM - EPDM auf Anfrage)	

Matériaux et Composants	FR	Materiales y Componentes	ES	Materialis e Componentes	PT
1 Corps: Laiton nickelé		1 Cuerpo en latón niquelado		1 Corpo em latão niquelado	
2 Poussoir: Laiton nickelé		2 Anillo de extracción tubo en latón niquelado		2 Anilha de liberação em latão niquelado	
3 Capsule de retenue: Laiton nickelé		3 Cápsula en latón niquelado		3 Cápsula de latão niquelado	
4 Rondelle d'accrochage: AISI 301		4 Pinza de agarre en acero inox AISI 301		4 Pinça de travamento em aço-inox AISI 301	
5 Anneau de positionnement: Technopolymère		5 Anillo de posicionamiento en tecnopolímero		5 Anel de posicionamento em tecnopolímero	
6 Joint à lèvres: NBR (FKM - EPDM sur demande)		6 Junta de forma en NBR (FKM y EPDM bajo pedido)		6 Vedação em NBR (FKM ou EPDM sob encomenda)	
7 Joint d'étanchéité du filetage: NBR (FKM - EPDM sur demande)		7 Junta rosca en NBR (FKM y EPDM bajo pedido)		7 Vedação da rosca em NBR (FKM ou EPDM sob encomenda)	
8 Bague de sécurité en laiton nickelé		8 Base roscada en latón niquelado		8 Base roscada em latão niquelado	
9 Seeger		9 Seeger		9 Seeger	
10 Joint en NBR (FKM - EPDM sur demande)		10 Junta en NBR (FKM y EPDM bajo pedido)		10 Vedação em NBR (FKM ou EPDM sob encomenda)	



**Pressioni**

Pressures

Druckbereich

Pressions

Presiones

Pressões

- 0.99 bar (-0.099 MPa)

20 bar (2.0 MPa)



**Fluidi compatibili**

Aria compressa / Vuoto / Acqua / Vapore

Fluids

Compressed air / Vacuum / Water / Steam

Geeignete Medien

Druckluft / Vakuum / Wasser / Dampf

Fluides compatibles

Air comprimé / Vide / Eau / Vapeur

Fluidos compatibles

Aire comprimido / Vacío / Agua / Vapor

Fluidos compatíveis

Ar comprimido / Vácuo / Água / Vapor



**Temperature**

Temperatures

Temperatur

Températures

Temperaturas

Temperaturas

- 20 °C

+ 80 °C

**EPDM**

- 40 °C

+ 130 °C

**FKM**

- 15 °C

+ 130 °C



**Tubi di Collegamento**

Tubi in materiale plastico:

PA6, PA11, PA12, Polietilene, \*Poliuretano, PTFE, FEP.

\*Per tubi in Poliuretano é consigliata una durezza di 98 shore.

**Connection Tubes**

Plastic tubes:

PA6, PA11, PA12, Polyethylene, \*Polyurethane, PTFE, FEP.

\*For Polyurethane hoses it is required a minimum hardness of 98 shore.

**Geeignete Rohre**

Kunststoffrohre:

PA6, PA11, PA 12, Polyethylene, \*Polyurethan, PTFE, FEP.

\*Für Polyurethan Rohre ist eine Härte von 98 Shore empfohlen.

**Tubes Conseillés**

Tubes plastiques:

PA6, PA11, PA12, Polyéthylène, \*Polyuréthane, PTFE, FEP.

\*Pour les tubes en polyuréthane, il est conseillé une dureté de 98 Shore.

**Tubos de Conexión**

Tubos en material plástico:

PA6, PA11, PA 12, Polietileno, \*Poliuretano, PTFE, FEP.

\*Para tubos en poliuretano es aconsejada una dureza de 98 shore.

**Tubos de Conexão**

Tubos em material plástico:

PA6, PA11, PA12, Polietileno, \*Poliuretano, PTFE, FEP.

\*Para tubos em Poliuretano é requerida uma dureza de 98 shore.



<b>Filettatura</b> Gas conica "UNIVERSAL SHORT". Gas cilindrica UNF conforme ANSI B1.1 NPTF conforme ANSI B1.20.5	<b>IT</b>	<b>Threads</b> "UNIVERSAL SHORT" Tapered thread. Parallel gas UNF conformity with ANSI B1.1 NPTF conformity with ANSI B1.20.5	<b>GB</b>	<b>Gewindearten</b> Konisches Gewinde "UNIVERSAL SHORT". Zylindrisches Gewinde UNF nach Norm ANSI B1.1 NPTF nach Norm ANSI B1.20.5	<b>DE</b>
<b>Filetages</b> Filetage conique "UNIVERSAL SHORT". Filetage cylindrique UNF conforme ANSI B1.1 NPTF conforme ANSI B1.20.5	<b>FR</b>	<b>Roscas</b> Gas cónica "UNIVERSAL SHORT". Gas cilindrica UNF conforme ANSI B1.1 NPTF conforme ANSI B1.20.5	<b>ES</b>	<b>Roscas</b> Gas cónica "UNIVERSAL SHORT". Gas paralela UNF conforme ANSI B1.1 NPTF conforme ANSI B1.20.5	<b>PT</b>



**UNIVERSAL SHORT**

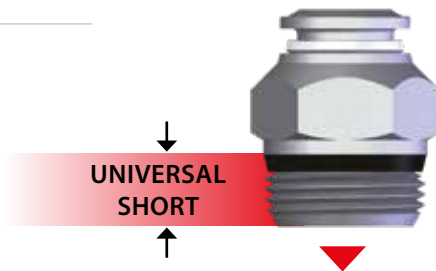

<p><b>NPT</b> <b>NPTF</b></p>	Conica Tapered Konisch Conique Cónica Cônica	<p><b>ISO 7</b> <b>BSPP</b></p>	Cilindrica Paralell Zylindrisch Cylindrique Cilíndrica Paralela	<p><b>ISO 7</b> <b>BSPT</b> <b>PT</b></p>	Conica Tapered Konisch Conique Cónica Cônica	<p><b>ISO 228</b> <b>BSP</b> <b>PF</b></p>	Cilindrica Paralell Zylindrisch Cylindrique Cilíndrica Paralela
-----------------------------------	---	-------------------------------------	--	---	---	--	--

<b>"UNIVERSAL SHORT"</b> La filettatura conica "UNIVERSAL SHORT" è progettata per soddisfare le seguenti caratteristiche: <ul style="list-style-type: none"> <li>• ridurre la lunghezza d'ingombro;</li> <li>• ridurre la chiave rispetto ad alcuni raccordi con filettature cilindriche;</li> <li>• consentire l'accoppiamento con diversi standard di filettature femmina sia coniche che cilindriche.</li> </ul>	<b>IT</b>	<b>"UNIVERSAL SHORT"</b> The "UNIVERSAL SHORT" taper thread has been designed to offer the following advantages to the users: <ul style="list-style-type: none"> <li>• reduced overall length;</li> <li>• smaller hex dimensions compared to the parallel threads;</li> <li>• to allow the assembly with different female threads both taper as well as parallel.</li> </ul>	<b>GB</b>	<b>"UNIVERSAL SHORT"</b> Das konische Gewinde "UNIVERSAL SHORT" ist so konzipiert, dass folgende Vorteile erzielt werden: <ul style="list-style-type: none"> <li>• Reduzierung der Länge des Gewindes - kürzere Montagezeit;</li> <li>• Reduzierung der Schlüsselweite im Vergleich von Verschraubungen mit zylindrischen Gewinden - geringerer Lochabstand;</li> <li>• Ermöglicht den Einsatz in verschiedene Gewindearten, sowie in konische- und zylindrische Innengewinde.</li> </ul>	<b>DE</b>
<b>"UNIVERSAL SHORT"</b> Le filetage conique "UNIVERSAL SHORT" a été conçu pour satisfaire les exigences suivantes: <ul style="list-style-type: none"> <li>• réduire la longueur d'encombrement;</li> <li>• réduire les dimensions hexagonales par rapport au filetage cylindrique;</li> <li>• permettre le montage avec divers taraudages standards soit coniques soit cylindriques.</li> </ul>	<b>FR</b>	<b>"UNIVERSAL SHORT"</b> La rosca cónica "UNIVERSAL SHORT" ha sido proyectada para satisfacer las siguientes características: <ul style="list-style-type: none"> <li>• reducir la longitud;</li> <li>• reducir la llave respecto a algunos racores con rosca cilíndrica;</li> <li>• permitir el acoplamiento con diferentes standard de roscas hembra sean cónicas o cilíndricas.</li> </ul>	<b>ES</b>	<b>"UNIVERSAL SHORT"</b> A rosca cónica "UNIVERSAL SHORT" é projetada para satisfazer às seguintes características: <ul style="list-style-type: none"> <li>• reduzir o comprimento da conexão;</li> <li>• reduzir o dimensional com relação às roscas paralelas;</li> <li>• permitir o acoplamento da conexão a diferentes tipos de rosca fêmea, sejam elas cónicas ou paralelas.</li> </ul>	<b>PT</b>



Inclinate  
Inclined  
Geneigt  
Incliné  
Inclinada  
Inclinadas



Concave  
Concave  
Konkav  
Concave  
Cóncava  
Côncavas



Convexe  
Convex  
Konvex  
Convexe  
Convexa  
Convexas

Consentire una completa tenuta anche su superfici non perfettamente piane, concave, convesse o inclinate, con diversi smussi o raggi.	<b>IT</b>	To ensure the right tightening also with surfaces not perfectly flat, without spot-facing, concave convex and with different kinds of chamfers or radius.	<b>GB</b>	Eine vollständige Abdichtung ist auch auf unebenen Flächen, wie geneigt, konkav oder konvex und mit unterschiedlichen Radien oder Fasen gewährleistet.	<b>DE</b>
Pour permettre une parfaite étanchéité même sur des surfaces non planes, concaves, convexas ou inclinées et avec différents chanfreins ou rayons.	<b>FR</b>	Consentir una completa estanqueidad incluso en superficies no perfectamente planas, cóncavas, convexas o inclinadas, con diferentes ángulos o radios.	<b>ES</b>	Permite um aperto correto em superfícies não perfeitamente planas, côncavas, convexas ou inclinadas, com diferentes chanfros ou raios.	<b>PT</b>



### Coppia di serraggio

Torque specifications

Angaben Drehmoment

Couple de serrage

Par de apriete

Especificações de Torque



UNF



"UNIVERSAL SHORT"

I valori di rottura possono variare in base all'articolo  
 Breaking values may vary according to the item  
 Die maximal werte dienen nur zu informationszwecken  
 Les valeurs maximales sont présentées à titre indicatif  
 Los valores de rotura pueden variar en función del artículo  
 Los valores de força pode variar em função artigo

MISURA MEASURE GRÖSSE DIMENSIONS MEDIDA MEDIDA	COPPIA CONSIGLIATA Nm RECOMMENDED TORQUE Nm EMPFOHLENES DREHMOMENT Nm COUPLE DE SERRAGE Nm PAR ACONSEJADO Nm TORQUE RECOMENDADO Nm	COPPIA DI ROTTURA Nm BREAKING TORQUE Nm ABSCHERDREHMOMENT Nm COUPLE DE RUPTURE Nm PAR DE ROTURA Nm BINÁRIO ROMPER Nm
10/32	0,8	3,2

MISURA MEASURE GRÖSSE DIMENSIONS MEDIDA MEDIDA	COPPIA MINIMA CONSIGLIATA Nm RECOMMENDED MINIMUM TORQUE Nm EMPFOHLENES DREHMOMENT Nm COUPLE DE SERRAGE Nm PAR MÍNIMO ACONSEJADO Nm TORQUE MÍNIMO RECOMENDADO Nm	COPPIA MASSIMA CONSIGLIATA Nm RECOMMENDED MAX TORQUE Nm ABSCHERDREHMOMENT Nm COUPLE DE RUPTURE Nm PAR MÁXIMO ACONSEJADO Nm TORQUE MÁXIMA RECOMENDADO Nm
1/8	5	7
1/4	5	7
3/8	5	7
1/2	5	7

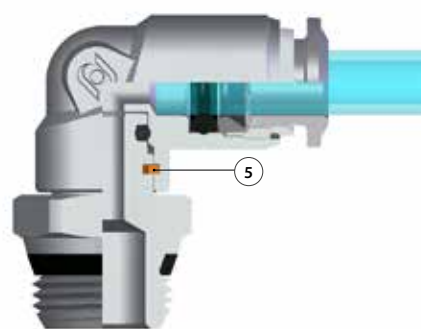
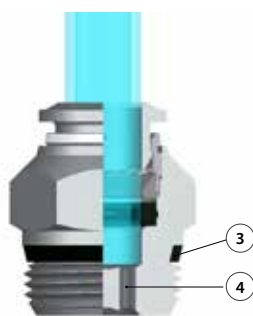
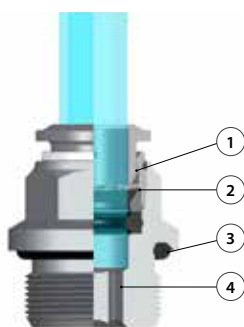

### Vantaggi

IT

- 1 La pinza in acciaio inox garantisce il perfetto aggiraffaggio di tubi di qualsiasi materiale senza danneggiarne la superficie. Il collegamento tra tubo e raccordo assicura una tenuta totale anche in condizioni di urti e vibrazioni.
- 2 La particolare geometria della guarnizione permette inoltre l'utilizzo dei raccordi anche con il vuoto.
- 3 Tutte le filettature di questa serie sono state dotate di elementi di tenuta che permettono l'immediato utilizzo dei raccordi riducendo notevolmente i tempi di installazione.
- 4 Tutti i raccordi dritti possono essere montati anche con chiave esagonale ed è possibile utilizzarli anche in spazi molto ridotti.
- 5 Raccordo orientabile con anello di sicurezza interno. Garantisce maggiore durata alla rotazione e trazione.

### Advantages

GB

- 1 The washer is made in stainless steel ensures the perfect tube clamping with every kinds of materials without damage the surface. The connection between the tube and the fitting ensure a total tightness even in severe conditions such as impact and vibrations.
- 2 The particular geometric shape of the seal ensure the perfect tightness even with vacuum.
- 3 All of threads from this range have been equipped with tightening parts which allow the direct assembly of the fittings, reducing the installation time.
- 4 All the straight fittings can be assembled also with Allen wrench and it is possible to use them in reduced spaces.
- 5 Orienting fitting with safety ring inside. Improved durability to the rotation and traction.

### Vorteile

DE

- 1 Konisches Gewinde "kurz" Die Zahnscheibe sorgt für eine perfekte Halterung des Rohres ohne die Oberfläche zu beschädigen. Die Dichtigkeit zwischen Rohr und Verschraubung ist auch bei Erschütterungen und Vibrationen gewährleistet.
- 2 Die besondere Geometrie der Dichtung ermöglicht auch die Anwendung der Verschraubungen in Verbindung mit Vakuum.
- 3 Alle Verschraubungen in dieser Serie sind mit Gewindeabdichtungen ausgestattet, die den sofortigen Einsatz ermöglichen und daher die Montagezeit stark reduzieren.
- 4 Alle geraden Verschraubungen können auch mit Inbusschlüsseln montiert werden, daher kleiner Lochabstand möglich.
- 5 Flexible Montage mit Sicherungsring innen. Verbesserte Beständigkeit gegenüber der Drehung und Traktions.

### Avantages

FR

- 1 La rondelle en acier inoxydable garantit la parfaite tenue du tube quelle que soit la matière et sans l'endommager. La connexion entre le tube et le raccord assure une étanchéité totale même dans des conditions d'impact ou de vibrations.
- 2 La spécificité géométrique du joint permet l'utilisation des raccords avec le vide.
- 3 Tous les filetages de cette série sont équipés d'éléments d'étanchéité qui permettent l'utilisation immédiate des raccords réduisant ainsi le temps d'installation.
- 4 Tous les raccords droits peuvent être aussi montés avec une clé hexagonale pour permettre une utilisation dans des espaces réduits.
- 5 Accessoire de fixation réglable avec anneau de sécurité à l'intérieur. Amélioration de la durée de la rotation et de traction.

### Ventajas

ES

- 1 La pinza en acero inoxidable garantiza el perfecto agarre del tubo de cualquier material sin perjudicar la superficie. La conexión entre tubo y racor asegura una estanqueidad total aun en condiciones de impacto o vibración.
- 2 La particular geometría de la junta garantiza una perfecta estanqueidad incluso en vacío.
- 3 Todas las rosas de esta serie están fabricadas con junta de cierre que permite la inmediata utilización del racor reduciendo notablemente el tiempo de instalación.
- 4 Todos los racores rectos pueden montarse también con llave hexagonal y es posible utilizarlos incluso en espacios muy reducidos.
- 5 Montaje ajustable con sistema de seguridad interior. La mejora de la durabilidad a la rotación y tracción.

### Vantagens

PT

- 1 A pinça em aço-inox garante o perfeito travamento do tubo de qualquer material sem danificar a superfície do mesmo. A conexão entre o tubo e a conexão assegura uma vedação total também em condições de impactos e vibrações.
- 2 A geometria particular da vedação permite a utilização da conexão também para aplicações com vácuo.
- 3 Todas as rosas desta série são dotadas de elementos de vedação, o que permite a imediata utilização das conexões, reduzindo notavelmente o tempo de instalação.
- 4 Todas as conexões retas podem ser montadas também com chave allenornando possível montagem das mesmas em espaços bem reduzidos.
- 5 Montagem ajustável com anel de segurança dentro. A durabilidade melhorada para a rotação e tração.



Articoli in comune con serie 57000 per tubi metrici - *Items in common with series 57000 for metric tubes*  
 Gleicher Artikel wie in Serie 57000 für metrische Rohre - *Article identique avec la série 57000 pour tube métrique*  
 Artículos en común con la serie 57000 para tubos métricos - *Código em comum com a série 57000 para tubos métricos*

## 89000

### RACCORDO DIRITTO MASCHIO "UNIVERSAL SHORT"

STRAIGHT MALE ADAPTOR "UNIVERSAL SHORT"

GERADE EINSCHRAUBVERSCHRAUBUNG KONISCH "UNIVERSAL SHORT"

RACCORD DROIT MÂLE, CONIQUE "UNIVERSAL SHORT"

RACOR RECTO MACHO CÓNICO "UNIVERSAL SHORT"

CONEXÃO RETA COM ROSCA "UNIVERSAL SHORT"

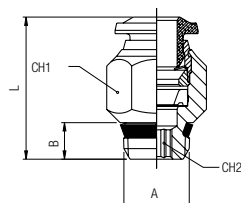

Code	Tube	A	B	L	CH1	CH2	Pack.
89000 00 019	1/8	10/32	5	19	8	2	10
89000 00 001	1/8	1/8	5.5	16.5	11	2	10
89000 00 002	1/8	1/4	7	18.5	11	2	10
* 89000 00 020	5/32 (4)	10/32	5	21	10	2	10
* 89000 00 003	5/32 (4)	1/8	5.5	18	11	3	10
* 89000 00 004	5/32 (4)	1/4	7	19	14	3	10
89000 00 021	1/4	10/32	5	24.5	13	2	10
89000 00 005	1/4	1/8	6.5	21.5	13	4	10
89000 00 006	1/4	1/4	7	20.5	14	4	10
89000 00 007	1/4	3/8	7.5	23	17	4	10
* 89000 00 008	5/16 (8)	1/8	5.5	24.5	14	5	10
* 89000 00 009	5/16 (8)	1/4	7	22	14	6	10
* 89000 00 010	5/16 (8)	3/8	7.5	23	17	6	10
* 89000 00 022	5/16 (8)	1/2	9	23.5	21	6	10
89000 00 011	3/8	1/8	5.5	27.5	17	6	10
89000 00 012	3/8	1/4	7	27.5	17	5	10
89000 00 013	3/8	3/8	7.5	25.5	17	7	10
89000 00 014	3/8	1/2	9	25.5	21	7	10
89000 00 015	1/2	1/8	5.5	32	20	5	10
89000 00 016	1/2	1/4	7	31	20	7	10
89000 00 017	1/2	3/8	7.5	31	20	9	10
89000 00 018	1/2	1/2	9	31	21	10	10

## 89010

### RACCORDO DIRITTO MASCHIO ESAGONO INCASSATO

STRAIGHT MALE ADAPTOR WITH EXAGON EMBEDDED

GERADE EINSCHRAUBVERSCHRAUBUNG MIT INNENSECHSKANT

RACCORD DROIT MÂLE, CONIQUE, 6-PANS INTERIEUR

RACOR RECTO MACHO CÓNICO HEXÁGONO INTERIOR

CONEXÃO RETA COM SEXTAVADO INTERNO E ROSCA

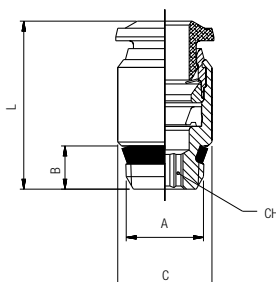

Code	Tube	A	B	C	L	CH	Pack.
* 89010 00 001	5/32 (4)	1/8	7.5	11	19	3	10
* 89010 00 002	5/16 (8)	1/8	7.5	14	25.5	5	10
* 89010 00 003	5/16 (8)	1/4	11	14	25	6	10

## 89030

### RACCORDO DIRITTO FEMMINA (NPTF)

STRAIGHT FEMALE ADAPTOR (NPTF)

AUFSCRAUBVERSCHRAUBUNG (NPTF)

RACCORD DROIT, TARAUEE (NPTF)

RACOR RECTO HEMBRA (NPTF)

CONEXÃO RETA COM ROSCA FÊMEA (NPTF)

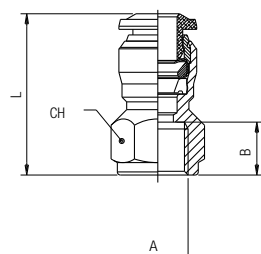

Code	Tube	A-NPTF	B	L	CH	Pack.
89030 00 001	1/8	1/8	9.5	24	13	10
89030 00 002	1/8	1/4	13.5	29	16	10
89030 00 003	5/32 (4)	1/8	9.5	24.5	13	10
89030 00 004	5/32 (4)	1/4	13.5	29.5	16	10
89030 00 005	1/4	1/8	9.5	26	13	10
89030 00 006	1/4	1/4	13.5	31	16	10
89030 00 007	3/8	1/4	13.5	34.5	18	10
89030 00 008	3/8	3/8	13.5	34.5	20	10

## 89040

### RACCORDO DIRITTO INTERMEDIO

STRAIGHT CONNECTOR  
 VERBINDUNGSVERSCHRAUBUNG  
 RACCORD UNION DOUBLE  
 RACOR RECTO INTERMEDIO  
 CONEXÃO RETA TUBO-TUBO

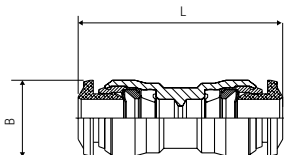

Code	Tube	Tube	L	B	Pack.
89040 00 001	1/8		8.5	26	10
* 57040 00 001	5/32 (4)		10.5	30.5	10
89040 00 003	1/4	5/32 (4)	12.5	33	10
89040 00 004	1/4		12.5	34	10
* 57040 00 008	3/16 (5)		11,5	33	10
* 57040 00 005	5/16 (8)		14.5	36	10
89040 00 006	3/8	1/4	17.5	41	10
89040 00 009	3/8	1/2	20.5	47	10
89040 00 007	3/8		17.5	41	10
89040 00 008	1/2		20.5	47	10

## 89050

### RACCORDO DIRITTO INTERMEDIO DI ATTRAVERSAMENTO

BULKHEAD CONNECTOR  
 SCHOTTVERSCHRAUBUNG  
 RACCORD TRAVERSÉE DE CLOISON  
 RACOR RECTO INTERMEDIO PASATABIQUES  
 CONEXÃO PASSA-MURO RETA TUBO-TUBO

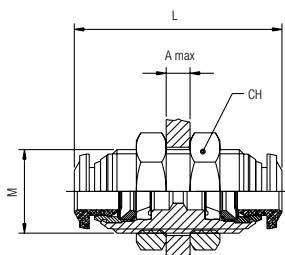

Code	Tube	M	L	CH	A max	Pack.
89050 00 001	1/8	M10x1	26	14	5	10
* 57050 00 001	5/32 (4)	M12x1	31.5	17	7	10
89050 00 003	1/4	M14x1	35	17	9.5	10
* 57050 00 003	5/16 (8)	M16x1	37	19	10.5	10
89050 00 005	3/8	M20x1	42	24	12.5	10
89050 00 006	1/2	M22x1	48	26	16.5	10

## 89055

**New**

### RACCORDO DIRITTO DI ATTRAVERSAMENTO FEMMINA (NPTF)

FEMALE BULKHEAD CONNECTOR (NPTF)  
 SCHOTTVERSCHRAUBUNG INNENGEWINDE (NPTF)  
 TRAVERSÉE DE CLOISON FEMELLE (NPTF)  
 RACOR RECTO INTERMEDIO PASATABIQUES HEMBRA (NPTF)  
 CONEXÃO PASSA-MURO RETA FEMEA (NPTF)

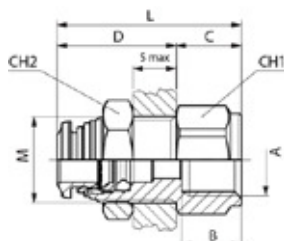

Code	Tube	A NPTF	B	M	S max	CH1	CH2	C	D	L	Pack.
89055 00 001	5/32 (4)	1/8	9.5	M12x1	7	15	17	10	19	29	10
89055 00 009	5/32 (4)	1/4	13.5	M12x1	7	16	17	15	19	34	10
89055 00 002	1/4	1/8	9.5	M14x1	8	16	17	10	21	31	10
89055 00 003	1/4	1/4	13.5	M14x1	8	16	17	15	21	36	10
89055 00 010	1/4	3/8	13.5	M14x1	8	20	17	15	21	36	10
89055 00 004	5/16 (8)	1/8	9.5	M16x1	8	18	19	10	22	32	10
89055 00 005	5/16 (8)	1/4	13.5	M16x1	8	18	19	12	22	34	10
89055 00 011	5/16 (8)	3/8	13.5	M16x1	8	20	19	15	22	37	10
89055 00 006	3/8	3/8	13.5	M20x1	9.5	24	24	14	25.5	39.5	10
89055 00 007	1/2	3/8	13.5	M22x1	10.5	24	26	15	27.5	42.5	10
89055 00 008	1/2	1/2	17.5	M22x1	10.5	24	26	20	27.5	47.5	10

## 89106

### RACCORDO A L ORIENTABILE FEMMINA (NPTF)

ORIENTING ELBOW FEMALE ADAPTOR (NPTF)  
 AUFSCRAUB-WINKELSCHRAUBUNG (DREHBAR) (NPTF)  
 EQUERRE ORIENTABLE, TARAUEE (NPTF)  
 RACOR A L ORIENTABLE HEMBRA (NPTF)  
 CONEXÃO EM "L" ORIENTÁVEL COM ROSCA FÊMEA (NPTF)

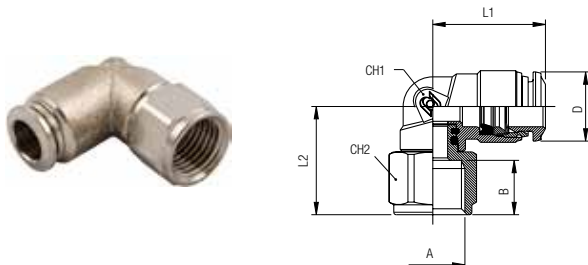

Code	Tube	A-NPTF	B	L1	L2	CH1	CH2	D	Pack.
89106 00 001	5/32 (4)	1/8	9.5	17.5	17.5	9	13	10	10
89106 00 002	5/32 (4)	1/4	13.5	17.5	20	9	16	10	10
89106 00 003	1/4	1/8	9.5	21.5	19	11	13	12.5	10
89106 00 004	1/4	1/4	13.5	21.5	21.5	11	16	12.5	10
89106 00 005	3/8	1/8	9.5	27	23	13	13	17.5	10
89106 00 006	3/8	1/4	13.5	27	24	16	16	17.5	10

## 89111

### RACCORDO A L ORIENTABILE MASCHIO "UNIVERSAL SHORT"

ORIENTING ELBOW MALE ADAPTOR "UNIVERSAL SHORT"  
 WINKELVERSCHRAUBUNG KONISCH (DREHBAR) "UNIVERSAL SHORT"  
 EQUERRE ORIENTABLE MÂLE, CONIQUE "UNIVERSAL SHORT"  
 RACOR A L ORIENTABLE MACHO "UNIVERSAL SHORT"  
 CONEXÃO MACHO EM "L" ORIENTÁVEL COM ROSCA "UNIVERSAL SHORT"

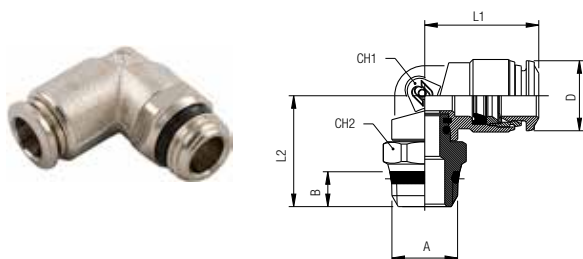

Code	Tube	A	B	L1	L2	CH1	CH2	D	Pack.
89111 00 001	1/8	1/8	5.5	16.5	19.5	9	13	10	10
89111 00 002	1/8	1/4	7	16.5	21	9	15	10	10
* 89111 00 003	5/32 (4)	1/8	5.5	18	19.5	9	13	10	10
* 89111 00 004	5/32 (4)	1/4	7	18	21	9	15	10	10
89111 00 005	1/4	1/8	5.5	21	21.5	11	13	12.5	10
89111 00 006	1/4	1/4	7	21	23	11	15	12.5	10
89111 00 007	1/4	3/8	7.5	21	23.5	11	17	12.5	10
* 89111 00 008	5/16 (8)	1/8	5.5	22.5	22.5	12	13	14.5	10
* 89111 00 009	5/16 (8)	1/4	7	22.5	22.5	12	15	14.5	10
* 89111 00 010	5/16 (8)	3/8	7.5	22.5	23	12	17	14.5	10
* 89111 00 018	5/16 (8)	1/2	9	22.5	25.5	12	13	14.5	10
89111 00 011	3/8	1/8	5.5	26.5	24	14	14	17.5	10
89111 00 012	3/8	1/4	7	26.5	26.5	14	16	17.5	10
89111 00 013	3/8	3/8	7.5	26.5	24.5	14	17	17.5	10
89111 00 014	3/8	1/2	9	26.5	27	14	21	17.5	10
89111 00 015	1/2	1/4	7	31.5	28.7	16	16	21.5	10
89111 00 016	1/2	3/8	7.5	31.5	26.5	16	17	21.5	10
89111 00 017	1/2	1/2	9	31.5	29	16	21	21.5	10

## 89116

### RACCORDO A L ORIENTABILE MASCHIO CILINDRICO

ORIENTING ELBOW MALE ADAPTOR (PARALLEL)  
 WINKELVERSCHRAUBUNG ZYLINDRISCH (DREHBAR)  
 EQUERRE ORIENTABLE MÂLE, CYLINDRIQUE  
 RACOR A L ORIENTABLE MACHO CILÍNDRICO CON TÓRICA  
 CONEXÃO MACHO EM "L" ORIENTÁVEL COM ROSCA PARALELA

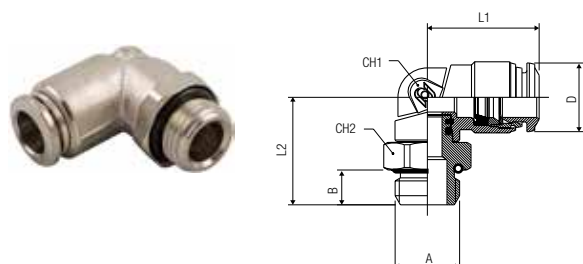

Code	Tube	A	B	L1	L2	CH1	CH2	D	Pack.
89116 00 001	1/8	10/32	4.5	16	17.5	9	8	10	10
* 89116 00 002	5/32 (4)	10/32	4.5	17.5	17.5	9	8	10	10
89116 00 003	1/4	10/32	4.5	21	19.5	11	11	12.5	10

## 89130

### RACCORDO A L INTERMEDIO

ELBOW CONNECTOR  
WINKELVERSCHRAUBUNG  
RACCORD EQUERRE  
RACOR A L INTERMEDIO  
CONEXÃO EM "L" TUBO-TUBO

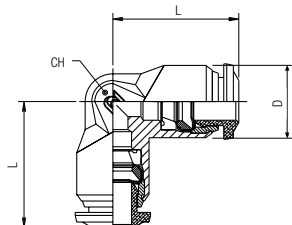

Code	Tube	L	CH	D	Pack.
89130 00 001	1/8	16.5	9	10	10
* 57130 00 001	5/32 (4)	17	9	10	10
89130 00 003	1/4	21	11	12.5	10
* 57130 00 003	5/16 (8)	22.5	13	14	10
89130 00 005	3/8	26	16	17.5	10
89130 00 006	1/2	30.5	19	21.5	10

## 89211

### RACCORDO A T ORIENTABILE MASCHIO "UNIVERSAL SHORT"

ORIENTING TEE MALE ADAPTOR "UNIVERSAL SHORT" - CENTRE LEG  
T-EINSCHRAUBVERSCHRAUBUNG KONISCH (DREHBAR) "UNIVERSAL SHORT"  
TÉ ORIENTABLE À PIQUAGE MÂLE CENTRAL, CONIQUE "UNIVERSAL SHORT"  
RACOR A T ORIENTABLE MACHO CENTRAL CÓNICO "UNIVERSAL SHORT"  
CONEXÃO EM "T" CENTRAL ORIENTÁVEL COM ROSCA MACHO "UNIVERSAL SHORT"

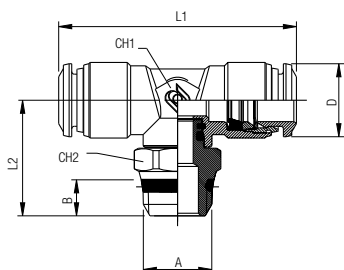

Code	Tube	A	B	L1	L2	CH1	CH2	D	Pack.
89211 00 001	1/8	1/8	5.5	34	17	9	8	10	10
89211 00 002	1/8	1/4	7	34	20	9	15	10	10
* 89211 00 003	5/32 (4)	1/8	5.5	34	20	9	13	10	10
* 89211 00 004	5/32 (4)	1/4	7	34	21.5	9	15	10	10
89211 00 005	1/4	1/8	5.5	40	20	11	13	12.5	10
89211 00 006	1/4	1/4	7	40	21.5	11	16	12.5	10
89211 00 007	1/4	3/8	7.5	40	22	11	17	12.5	10
* 89211 00 016	5/16 (8)	1/8	5.5	45	25.5	13	13	14.5	10
* 89211 00 015	5/16 (8)	1/4	7	45	25.5	13	15	14.5	10
* 89211 00 017	5/16 (8)	3/8	7.5	45	26	13	17	14.5	10
89211 00 014	3/8	1/8	5.5	52	26.5	14	14	17.5	10
89211 00 008	3/8	1/4	7	52	29	14	16	17.5	10
89211 00 009	3/8	3/8	7.5	52	27	14	17	17.5	10
89211 00 010	3/8	1/2	9	52	31	14	21	17.5	10
89211 00 011	1/2	1/4	7	61	31.5	16	16	21.5	10
89211 00 012	1/2	3/8	7.5	61	29.5	16	17	21.5	10
89211 00 013	1/2	1/2	9	61	32	16	21	21.5	10

## 89216

### RACCORDO A T ORIENTABILE MASCHIO CILINDRICO

ORIENTING TEE MALE ADAPTOR (PARALLEL) - CENTRE LEG  
T-EINSCHRAUBVERSCHRAUBUNG ZYLINDRISCH (DREHBAR)  
TÉ ORIENTABLE À PIQUAGE MÂLE CENTRAL, CYLINDRIQUE  
RACOR A T ORIENTABLE MACHO CENTRAL CILÍNDRICO CON TÓRICA  
CONEXÃO MACHO EM "T" ORIENTÁVEL COM ROSCA PARALELA

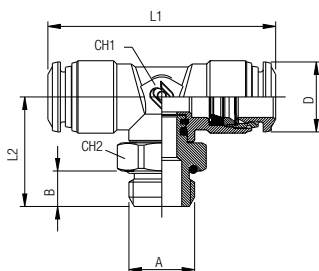

Code	Tube	A	B	L1	L2	CH1	CH2	D	Pack.
89216 00 001	1/8	10/32	4.5	33	17	9	8	10	10
* 89216 00 002	5/32 (4)	10/32	4.5	34	18	9	8	10	10
89216 00 003	1/4	10/32	4.5	42	20.5	11	11	12.5	10



## 89223

### RACCORDO A T ORIENTABILE MASCHIO LATERALE "UNIVERSAL SHORT"

ORIENTING TEE MALE ADAPTOR "UNIVERSAL SHORT" OFF - SET LEG  
 L-EINSCHRAUBVERSCHRAUBUNG KONISCH (DREHBAR) "UNIVERSAL SHORT"  
 TÉ ORIENTABLE À PIQUAGE LATÉRAL, CONIQUE "UNIVERSAL SHORT"  
 RACOR A T ORIENTABLE MACHO LATERAL CÓNICO "UNIVERSAL SHORT"  
 CONEXÃO EM "T" LATERAL ORIENTÁVEL COM ROSCA MACHO "UNIVERSAL SHORT"

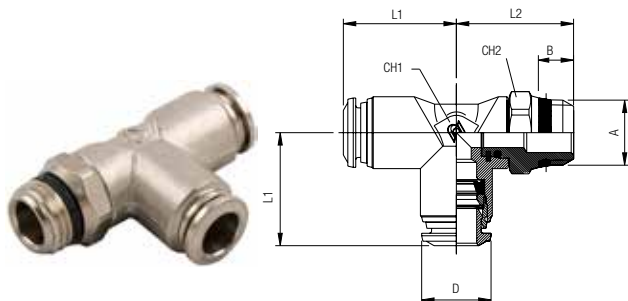

Code	Tube	A	B	L1	L2	CH1	CH2	D	Pack.
89223 00 001	1/8	1/8	5.5	16.5	18.5	9	13	10	10
89223 00 002	1/8	1/4	7	16.5	20.5	9	15	10	10
* 89223 00 003	5/32 (4)	1/8	5.5	17	20	9	13	10	10
* 89223 00 004	5/32 (4)	1/4	7	17	21.5	9	15	10	10
89223 00 005	1/4	1/8	5.5	21.5	20	11	13	12.5	10
89223 00 006	1/4	1/4	7	21.5	21.5	11	15	12.5	10
89223 00 007	1/4	3/8	7.5	21.5	22	11	17	12.5	10
* 89223 00 015	5/16 (8)	1/8	5.5	22.5	24	13	13	14.5	10
* 89223 00 016	5/16 (8)	1/4	7	22.5	24	13	15	14.5	10
* 89223 00 017	5/16 (8)	3/8	7.5	22.5	27	13	17	14.5	10
89223 00 014	3/8	1/8	5.5	27	26	14	14	17.5	10
89223 00 008	3/8	1/4	7	27	26.5	14	16	17.5	10
89223 00 009	3/8	3/8	7.5	27	27	14	17	17.5	10
89223 00 010	3/8	1/2	9	27	29	14	21	17.5	10
89223 00 011	1/2	1/4	7	31.5	31.5	16	16	21.5	10
89223 00 012	1/2	3/8	7.5	31.5	31.5	16	20	21.5	10
89223 00 013	1/2	1/2	9	31.5	32.5	16	21	21.5	10

## 89226

### RACCORDO A T ORIENTABILE MASCHIO LATERALE CILINDRICO

ORIENTING TEE MALE ADAPTOR (PARALLEL) - OFF - SET LEG  
 L-EINSCHRAUBVERSCHRAUBUNG ZYLINDRISCH (DREHBAR)  
 TÉ ORIENTABLE À PIQUAGE LATÉRAL, CYLINDRIQUE  
 RACOR A T ORIENTABLE MACHO LATERAL CILÍNDRICO CON TÓRICA  
 CONEXÃO MACHO EM "T" LATERAL ORIENTÁVEL COM ROSCA PARALELA

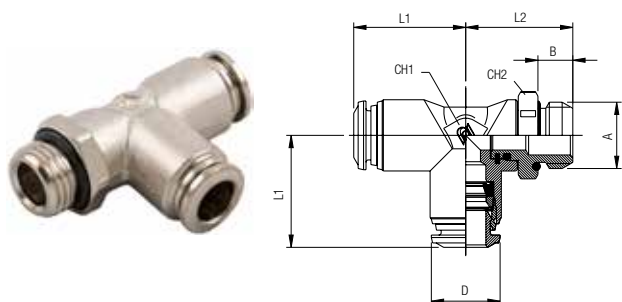

Code	Tube	A	B	L1	L2	CH1	CH2	D	Pack.
89226 00 001	1/8	10/32	4.5	16.5	17	9	8	10	10
* 89226 00 002	5/32 (4)	10/32	4.5	17	18	9	8	10	10
89226 00 003	1/4	10/32	4.5	21	20.5	11	11	12.5	10

## 89230

### RACCORDO A T INTERMEDIO

TEE CONNECTOR  
 T-ANSCHLUSS  
 RACCORD TÉ  
 RACOR A T INTERMEDIO  
 CONEXÃO EM "T" TUBO-TUBO

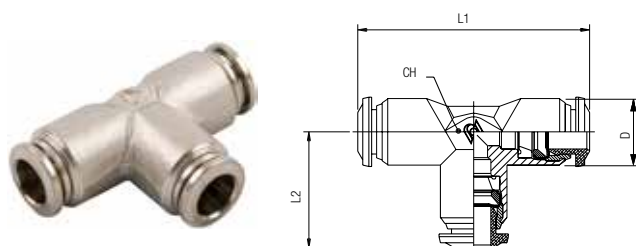

Code	Tube	L1	L2	CH	D	Pack.
89230 00 001	1/8	33	17	9	10	10
* 57230 00 001	5/32 (4)	34	17	9	10	10
89230 00 003	1/4	42	21	11	12.5	10
* 57230 00 003	5/16 (8)	45	22.5	13	14	10
89230 00 005	3/8	53	26.5	16	17.5	10
89230 00 006	1/2	61	30.5	19	21.5	10

## 89310

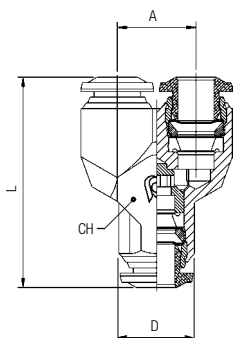
**RACCORDO A Y INTERMEDIO**
*Y CONNECTOR*
*Y-ANSCHLUSS*
*RACCORD Y SIMPLE*
*RACOR A Y INTERMEDIO*
*CONEXÃO EM "Y" TUBO-TUBO*

Code	Tube	A	L	CH	D	Pack.
89310 00 001	1/8	10	29	11	10	10
* 57310 00 001	5/32 (4)	11	32	11	10	10
89310 00 003	1/4	13.5	36.5	13	12.5	10
* 57310 00 003	5/16 (8)	15.5	41	13	14	10
89310 00 005	3/8	18.5	48	18	17.5	10

## 89500

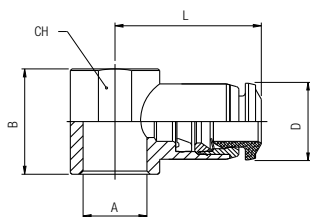
**ANELLO ORIENTABILE A L**
*SINGLE BANJO BODY*
*RINGANSCHLUSS*
*CORPS SIMPLE POUR BANJO*
*ANILLO ORIENTABLE SIMPLE*
*ANEL ORIENTÁVEL EM "L"*

Code	Tube	A	B	L	CH	D	Pack.
89500 00 002	1/8	1/8	15	19	14	10	10
* 57500 00 001	5/32 (4)	10/32	12.5	19	-	10	10
* 57500 00 003	5/32 (4)	1/8	15	21	14	10	10
89500 00 004	1/4	1/8	15	22.5	14	12.5	10
89500 00 005	1/4	1/4	17	25	18	12.5	10
* 57500 00 006	5/16 (8)	1/8	15	24	14	14	10
* 57500 00 007	5/16 (8)	1/4	17	26	18	14	10
* 57500 00 008	5/16 (8)	3/8	20	28	21	14	10
89500 00 006	3/8	1/4	17	29	18	17.5	10
89500 00 007	3/8	3/8	20	30.5	21	17.5	10
89500 00 008	1/2	3/8	20	32	21	21.5	10
89500 00 009	1/2	1/2	24	35	25	21.5	10

## 88610

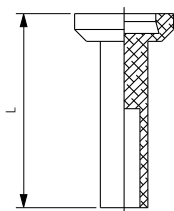
**TAPPO IN POLIAMIDE**
*POLYAMIDE PLUG*
*VERSCHLUSSZAPFEN POLYAMID*
*BOUCHON EN POLYAMIDE*
*TAPÓN EN POLIAMIDA*
*TAMPÃO EM POLIAMIDA*

Code	Tube	L	Pack.
88610 00 31 02 NE	1/8	18	10
88610 00 31 27 NE	5/32 (4)	23.5	10
88610 00 31 03 NE	1/4	24.5	10
88610 00 31 28 NE	5/16 (8)	26	10
88610 00 31 04 NE	3/8	28.5	10
88610 00 31 05 NE	1/2	28.5	10

## 89700

### RIDUZIONE

REDUCER  
REDUZIERUNG  
RÉDUCTION ENCLIQUETABLE  
REDUCCIÓN  
REDUÇÃO

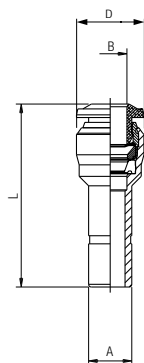

Code	A	B	L	D	Pack.
89700 00 001	1/4	1/8	30	10	10
89700 00 002	1/4	5/32 (4)	30	10	10
* 57700 00 008	5/16 (8)	5/32 (4)	33	10	10
89700 00 003	3/8	1/4	35.5	12.5	10
89700 00 006	3/8	5/16 (8)	36.5	14	10
89700 00 004	1/2	1/4	43	12.5	10
89700 00 005	1/2	3/8	43	17.5	10

## 50980

### CLIP DI SICUREZZA

SECURITY CLIPS  
SICHERHEITSClip  
CLIP DE SECURITÉ  
CLIP DE SEGURIDAD ROJO  
CLIP DE SEGURANÇA

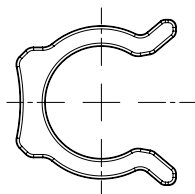

Code	Tube	Pack.
50980 00 32 X1 RO	5/32 (4)	50
50980 00 32 X4 RO	1/4 (6)	50
50980 00 32 X7 RO	5/16 (8)	50
50980 00 32 X9 RO	3/8 (10)	50
50980 00 32 Y1 RO	1/2 (12)	50

## 50990

### LEVA SGANCIO ADATTATORI

TOOL FOR DISASSEMBLING  
LÖSEWERKZEUG  
OUTIL DE DÉMONTAGE  
LLAVE DE DESMONTAJE  
FERRAMENTA PARA DESMONTAGEM

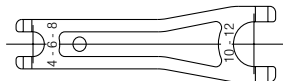

Code	Pack.
50990 00 001	10

## 50006

### ANELLO DI TENUTA PER FILETTI CONICI "UNIVERSAL SHORT"

THREAD PACKING FOR THE "UNIVERSAL SHORT" TAPER THREADS  
DICHTRINGE FÜR KONISCHE GEWINDE "UNIVERSAL SHORT"  
BAGUE D'ÉTANCHÉITÉ POUR FILETAGES CONIQUES "UNIVERSAL SHORT"  
JUNTA DE CIERRE PARA ROSCAS CÓNICAS "UNIVERSAL SHORT"  
ANEL DI VEDAÇÃO PARA ROSCAS CÓNICA "UNIVERSAL SHORT"



Code	Thread	Pack.
50006 00 24 02 00	1/8	10
50006 00 24 03 00	1/4	10
50006 00 24 04 00	3/8	10
50006 00 24 05 00	1/2	10