

3 SINGLE STATION SUBPLATES FOR VALVES SIZE 10

ISO 4401:2005
Mounting surface: 4401-05-05-0-05

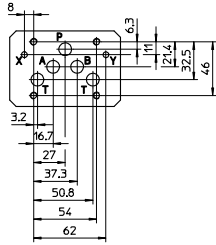

Matching valves

Set of screw
(to be ordered separately)

DK-11	SET SC-DK/DP-1
DK-12	SET SC-DK/DP-1
DKE	SET SC-DK/DP-1
DKQ	SET SC-DK/DP-1
DKZOR	SET SC-DK/DP-1
DKZA	SET SC-DK/DP-1
DLKZOR	SET SC-DK/DP-1
DLKZA	SET SC-DK/DP-1

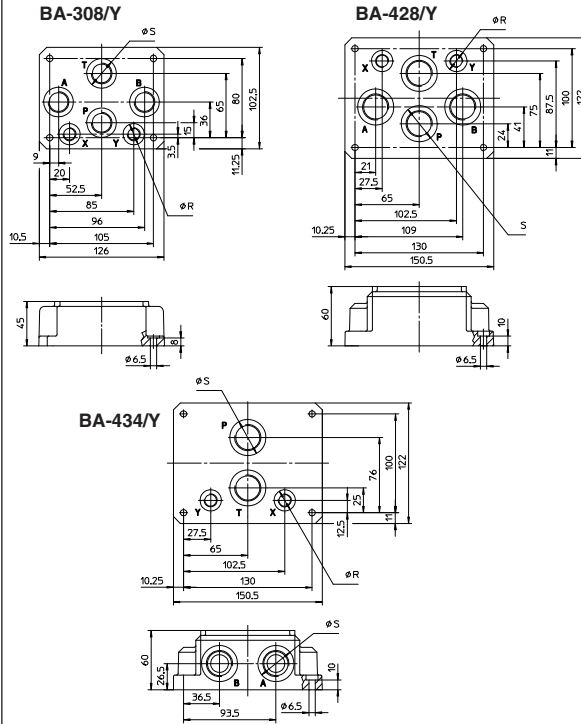

VERSIONS

BA-308: basic version without ports X and Y; ports P, A, B, T (1/2") on the base.

BA-428: basic version without ports X and Y; ports P, A, B, T (3/4") on the base.

BA-434: basic version without ports X and Y; ports P and T (3/4") on the base; ports A and B (3/4") on the side.

BA-*Y:** versions dimensionally analogous to the corresponding basic versions with the addition of X and Y ports (1/4") on the base (see figure on the left).

The /Y versions are always used for valves type DKZOR, DLKZO, when drainage from port Y is required.

X and Y ports are only present in the /Y versions.

Code	Ports (GAS) A,B,P,T	(X-Y)	Ø S [mm]	Counterbore R [mm]	Mass [Kg]
BA-308 (Y)	1/2"	(1/4")	30	21,5	2,5
BA-428 (Y)	3/4"	(1/4")	36,5	21,5	5,5
BA-434 (Y)	3/4"	(1/4")	36,5	21,5	8,5

4 SINGLE STATION SUBPLATES FOR VALVES SIZE 16

ISO 4401:2005
Mounting surface: 4401-07-07-0-05

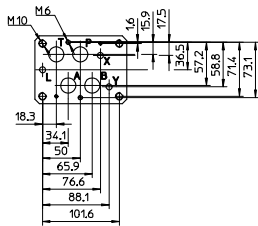

Matching valves

Set of screw
(to be ordered separately)

DP-21	SET SC-DP2
DP-24	SET SC-DP2
DP-25	SET SC-DP2
DPH-28	SET SC-DP2
DPH-29	SET SC-DP2
DPHI-2	SET SC-DP2
DPHE-2	SET SC-DP2
DPHA-2	SET SC-DP2
DPHW-2	SET SC-DP2
DPZO-*-2	SET SC-DP2
DPZA-*-2	SET SC-DP2

BA-518

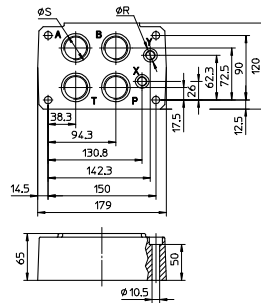

BA-519

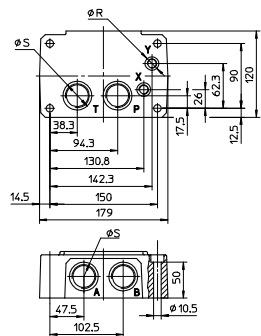

VERSIONS

BA-518: basic version with ports P, A, B, T (1") and X, Y (1/4") on the base.

BA-519: basic version with ports P, T (1") and X, Y (1/4") on the base; ports A, B (1") on the side.

Code	Ports (GAS) A,B,P,T	X-Y	Ø S [mm]	Counterbore R [mm]	Mass [Kg]
BA-518	1"	1/4"	46	21,5	8
BA-519	1"	1/4"	46	21,5	8

5 SINGLE STATION SUBPLATES FOR VALVES SIZE 25

ISO 4401:2005
Mounting surface: 4401-08-08-0-05

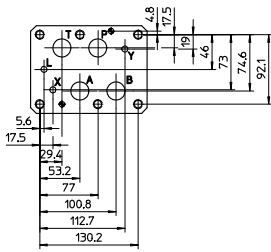

Matching valves

Set of screw
(to be ordered separately)

DP-41	SET SC-DP4
DP-44	SET SC-DP4
DP-45	SET SC-DP4
DPH-48	SET SC-DP4
DPH-49	SET SC-DP4
DPHI-4	SET SC-DP4
DPHE-4	SET SC-DP4
DPHA-4	SET SC-DP4
DPHW-4	SET SC-DP4
DPZO-*-4	SET SC-DP4
DPZA-*-4	SET SC-DP4

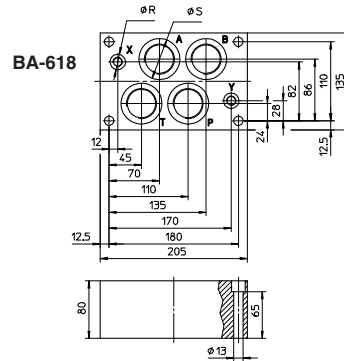
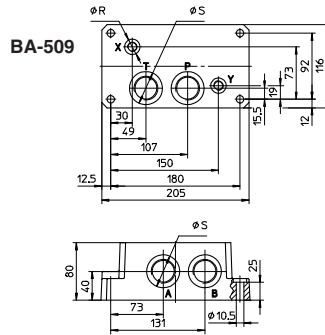

VERSIONS

BA-509: basic version with ports P, T (1") and X, Y (1/4") on the base, ports A, B (1") on the side.

BA-618: basic version with ports P, A, B, T (1 1/4") and X, Y (1/4") on the base.

Code	Ports (GAS)		Ø Counterbore		Mass [Kg]
	A,B,P,T	X-Y	S [mm]	R [mm]	
BA-509	1"	1/4"	46	21,5	12,5
BA-618	1 1/4"	1/4"	57	21,5	13,5

6 SINGLE STATION SUBPLATES FOR VALVES SIZE 32

ISO 4401:2005
Mounting surface: 4401-10-09-0-05

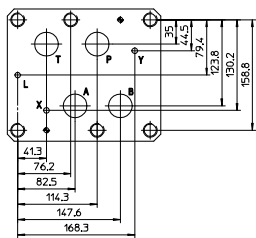

Matching valves

Set of screw
(to be ordered separately)

DP-64	SET SC-DP6
DP-65	SET SC-DP6
DPH-68	SET SC-DP6
DPH-69	SET SC-DP6
DPHI-6	SET SC-DP6
DPHE-6	SET SC-DP6
DPHA-6	SET SC-DP6
DPZO-*-6	SET SC-DP6
DPZA-*-6	SET SC-DP6

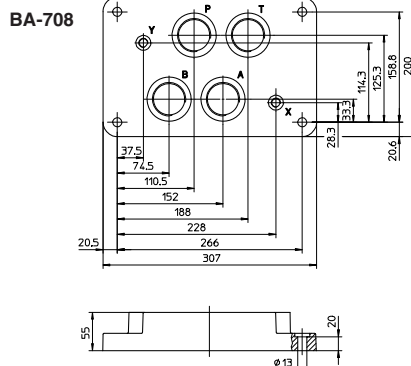

VERSIONS

BA-708: basic version with ports P, A, B, T (1 1/2") and X, Y (1/4") on the base.

Code	Ports (GAS)		Ø Counterbore		Mass [Kg]
	A,B,P,T	X-Y	S [mm]	R [mm]	
BA-708	1 1/2"	1/4"	63,5	21,5	17

7 SINGLE STATION SUBPLATES FOR PRESSURE CONTROL VALVE SIZE 10, 20 AND 32

Mounting surface
ISO 6264: 1998

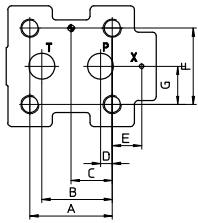

Matching valves Set of screw
to be ordered separately

AGAM-10	SET SC-AGA-10
AGMZO-10	SET SC-AGA-10
AGMZA-10	SET SC-AGA-10
AGAM-20	SET SC-AGA-20
AGMZO-20	SET SC-AGA-20
AGMZA-20	SET SC-AGA-20
AGAM-32	SET SC-AGA-32
AGMZO-32	SET SC-AGA-32
AGMZA-32	SET SC-AGA-32

size	A	B	C	D	E	F	G
10	53,8	47,5	22,1	22,1	-	53,8	26,9
20	66,7	55,6	33,4	11,1	23,8	70	35
32	88,9	76,2	44,5	12,7	31,8	82,6	41,3

BA-306
Mounting surface
ISO 6264-06-09-0-97

matching valves:
AGAM-10
AGMZO--10
AGMZA--10

BA-506
Mounting surface
ISO 6264-08-13-0-97

matching valves:
AGAM-20
AGMZO--20
AGMZA--20

BA-706
Mounting surface
ISO 6264-10-17-0-97

matching valves:
AGAM-32
AGMZO--32
AGMZA--32

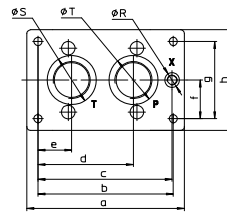

BA-306
BA-506
BA-706

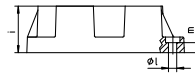

Code	a	b	c	d	e	f	g	h	i	l	m	Ø Blade	S	R	T
BA - 306	130	104	97	64,5	19,5	27	54	80	40	8,4	15	36,5	21,5	30	
BA - 506	180	150	133,25	92,25	37,25	75	105	50	10,5	13	46	21,5	46		
BA - 706	204	175	173,5	123,5	43,5	50	100	130,5	60	10,5	13	63,5	21,5	63,5	

VERSIONS

BA-306, BA-506, BA-706: basic version, see figure on left and dimensional tables.

Code	size	Ports (GAS)			Mass [Kg]
		P	T	X	
BA - 306	10	1/2"	3/4"	1/4"	1,5
BA - 506	20	1"	1"	1/4"	3,5
BA - 706	32	1 1/2"	1 1/2"	1/4"	6

Mounting surface
ISO 5781: 2000

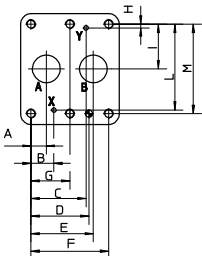
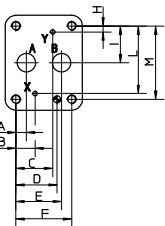
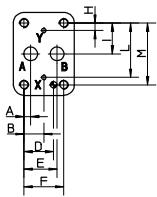

Matching valves Set of screw
to be ordered separately

AGI*-10(20)	SET SC-AGI
AGRL(E)-10(20)	SET SC-AGI
AGRCZO-10(20)	SET SC-AGI
AGRCZA-10(20)	SET SC-AGI
AGI*-32	SET SC-AGI-32
AGRL(E)-32	SET SC-AGRL-32

Mounting surface
ISO 5781-06-07-0-00

matching valves:
AGI*-10
AGRL-10
AGRL-10
AGRZO--10

Mounting surface
ISO 5781-08-10-0-00

matching valves:
AGI*-20
AGRL-20
AGRL-20
AGRZO--20

Mounting surface
ISO 5781-10-13-0-00

matching valves:
AGI*-32
AGRL-32
AGRL-32

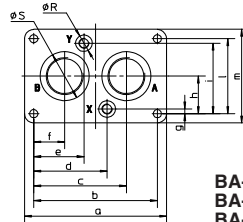

BA-305
BA-505
BA-705

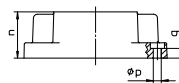

Code	a	b	c	d	e	f	g	h	i	l	m	n	p	q	Ø Blade	S	R
BA - 305	113	90	67	45	45	23	8	33,3	58,7	66,7	90	30	10,5	10	30	21,5	
BA - 505	133	110	82,5	64,5	45,5	27,5	6,4	39,7	73	79,4	102,5	42	10,5	10	46	21,5	
BA - 705	184	160	120	95	65	40	6	48,5	91	97	121	60	10,5	13	63,5	21,5	

VERSIONS

BA-305, BA-506 and BA-705: see figure on left and dimensional tables.

Code	size	Ports (GAS)			Mass [Kg]
		A	B	X-Y	
BA - 305	10	1/2"	1/2"	1/4"	1
BA - 505	20	1"	1"	1/4"	2
BA - 705	32	1 1/2"	1 1/2"	1/4"	7,5