

Cartridge pressure relief valves type CART

screw-in mounting, direct operated

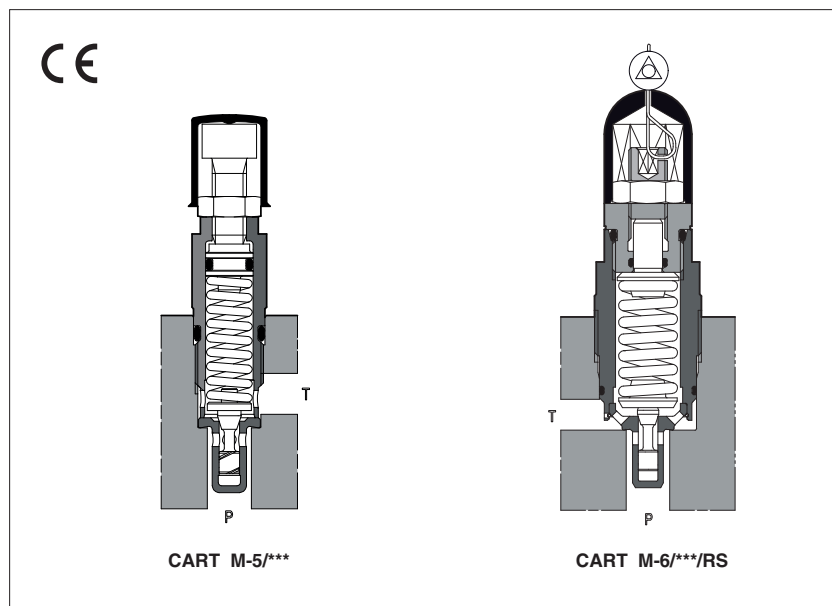

CART are screw-in, direct operated pressure relief valves.

They are used to limit the max pressure in the hydraulic systems or to protect part of the circuit from overpressure.

They are available in six sizes for different flow and pressure ranges.

The cartridge execution is specifically designed to reduce the dimension of blocks and manifolds, without penalizing the functional characteristics.

Option **RS**, conforms to the Machine Directive (2006/42/CE), with factory preset and lead sealed regulation.

The factory pressure setting required by the customer corresponds to the valve's cracking pressure.

Max flow: **150 l/min**

Max pressure: up to **420 bar**

1 MODEL CODE

CART	M-6	/	420	/	RS	/	*	**	/	*
Screw-in relief cartridges										Seals material, see section 4: - = NBR PE = FKM BT = HNBR
Size: M-3 = G1/2 (1) M-4 = M14x1 M-5 = M20x1,5 M-6 = M33x1,5 (1) ARE-15 = M32x1,5 ARE-20 = M35x1,5 (1)										Series number
Max pressure: see section 3										Only for RS option: 280 = factory pressure setting to be defined by the customer min step: 1 bar - min pressure setting: 25 bar (example 280 = 280 bar)
										Options: see section 5 for options availability and combination: R = leak free execution (2) RS = leak free execution plus lead sealed regulation conforming to 2006/42/CE Manual override only for standard and /R option (3): V = regulating handwheel VF = regulating knob VS = regulating knob with safety locking

For **PED** version see technical table CY010

(1) Available also in stainless steel execution, see technical table CW010

(2) Standard execution of CART M-4 and CART ARE-20 provides the leak free feature, then the /R is always present in the valve model code, with the exception in case of RS options

(3) For handwheel and knob features, see sections 7, 8. For their availability see section 5

2 HYDRAULIC SYMBOLS



3 HYDRAULIC CHARACTERISTICS

Valve model	CART M-3	CART M-4	CART M-5	CART M-6	CART ARE-15	CART ARE-20	
Max pressure setting [bar]	STANDARD	50 100 210 350 420	100 210	50 100 210 250 350	50 100 210 350 500	15 50 75 150 250 350 420	50 100 210
	R		350 420		50 100 210 350 500	15 50 75 150 250 420	315 400
	RS		220 270 350		220 270 330 350	150 190 230	
Pressure range [bar]	STANDARD (1)	4÷50 6÷100 7÷210 8÷350 15÷420	6÷100 7÷210	2÷50 3÷100 5÷210 7÷250 8÷350	2÷50 3÷100 8÷210 15÷350 15÷500	2÷15 3÷50 4÷75 8÷150 8÷250 8÷350 15÷420	3÷50 5÷100 6÷210
	R (1)		8÷350 15÷420		2÷50 3÷100 10÷210 15÷350 15÷500	2÷15 3÷50 4÷75 8÷150 8÷250 15÷420	8÷315 10÷400
	RS (1)		210÷260 260÷300 300÷370		200÷250 250÷290 290÷350 310÷370	130÷170 170÷210 210÷250	
Max pressure on port T [bar]	50	50	50	50	50	50	
Max flow [l/min]	STANDARD	2,5	15	35	40	75	120
	RS	2,5	15	50	60	100	150

(1) The values correspond to the min and max regulation of the valve's craking pressure

4 MAIN CHARACTERISTICS, SEALS AND FLUIDS - for other fluids not included in below table, consult our technical office

Assembly position	Any position		
Compliance	RoHS Directive 2011/65/EU as last update by 2015/65/EU REACH Regulation (EC) n°1907/2006		
Ambient temperature	Standard execution = -30°C ÷ +70°C /PE option = -20°C ÷ +70°C /BT option = -40°C ÷ +70°C		
Seals, recommended fluid temperature	NBR seals (standard) = -20°C ÷ +80°C, with HFC hydraulic fluids = -20°C ÷ +50°C FKM seals (/PE option) = -20°C ÷ +80°C HNBR seals (/BT option) = -40°C ÷ +60°C, with HFC hydraulic fluids = -40°C ÷ +50°C		
Recommended viscosity	15 ÷ 100 mm ² /s - max allowed range 2,8 ÷ 500 mm ² /s		
Max fluid contamination level	ISO 4406 class 20/18/15 NAS 1638 class 9, see also filter section www.atos.com or KTF catalog		
Hydraulic fluid	Suitable seals type	Classification	Ref. Standard
Mineral oils	NBR, FKM, HNBR	HL, HLP, HLPD, HVLP, HVLPD	DIN 51524
Flame resistant without water	FKM	HFDR, HFDR	ISO 12922
Flame resistant with water	NBR, HNBR	HFC	

5 OPTIONS AVAILABILITY

Valve model	CART M-3	CART M-4	CART M-5	CART M-6	CART ARE-15	CART ARE-20
Option	/R	STANDARD		●	●	STANDARD
	/RS		●		●	
	/V	●			●	●
	/VF				●	●
	/VS				●	●
Combinated option (1)	/RV			●	●	●
	/RVF			●	●	
	/RVS			●	●	

(1) **RV** = leak free and regulating handwheel
RVF = leak free and regulating knob
RVS = leak free and regulating knob with safety lock

6 REGULATED PRESSURE VERSUS FLOW DIAGRAMS (based on mineral oil ISO VG 46 at 50°C)

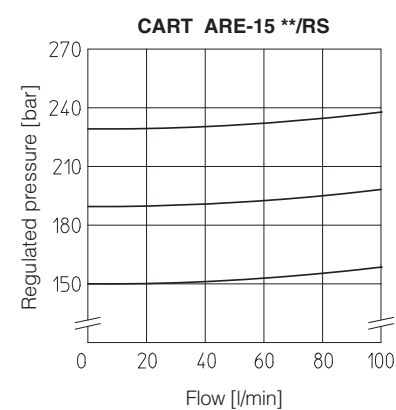
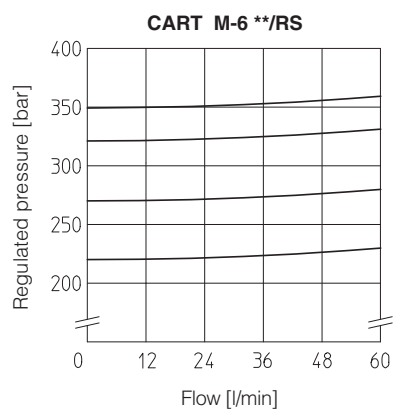
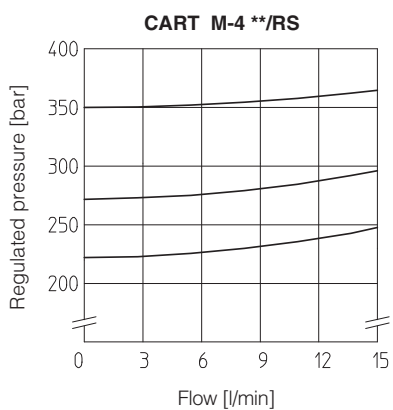
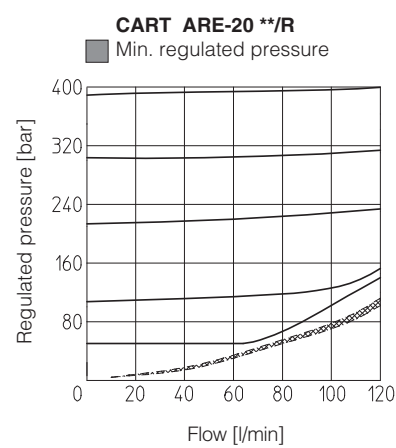
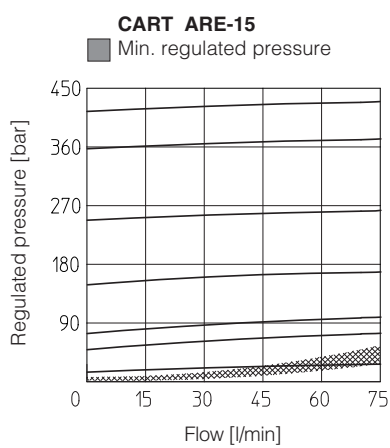
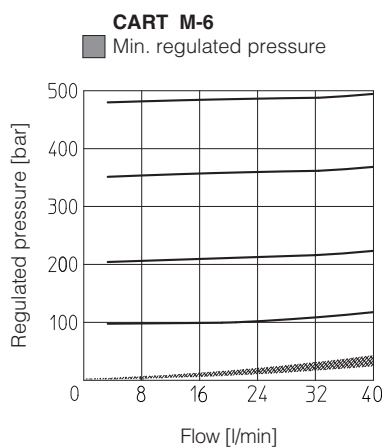
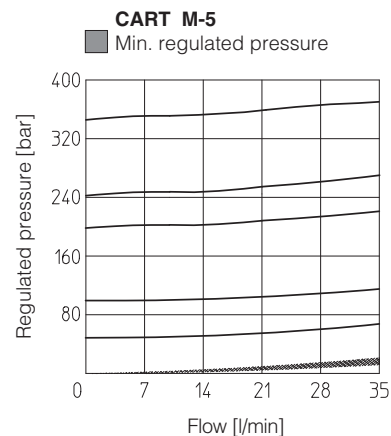
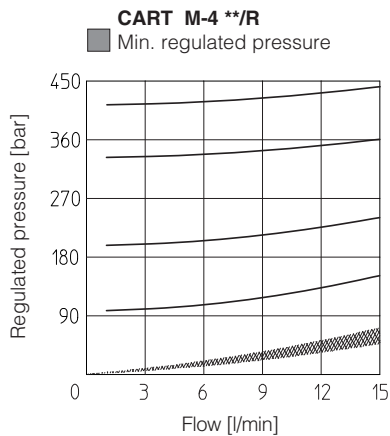
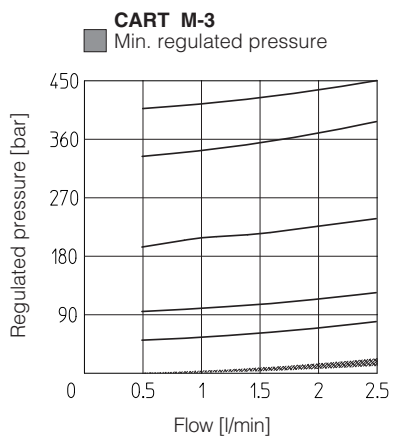

7 CAVITY AND DIMENSIONS FOR CART M-3, M-4 AND M-5 [mm]

CART M-3

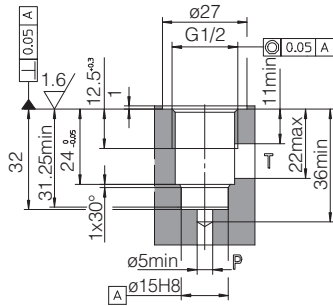

Standard

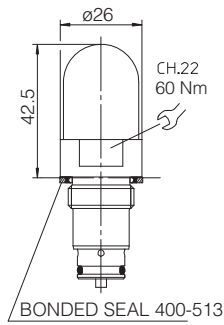

Option /V

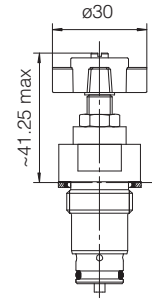

CART M-4

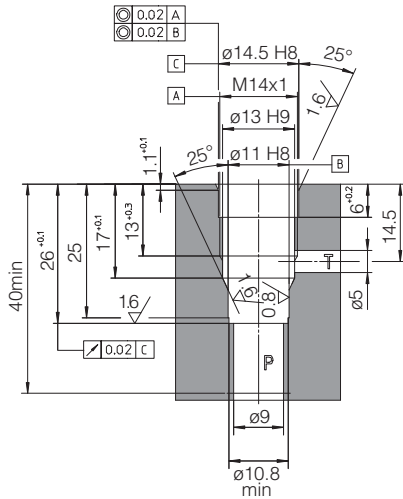

Cavity drawing not in scale
with the cartridge

Standard

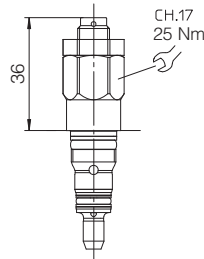

Option /RS

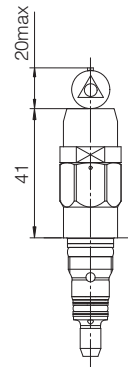

CART M-5

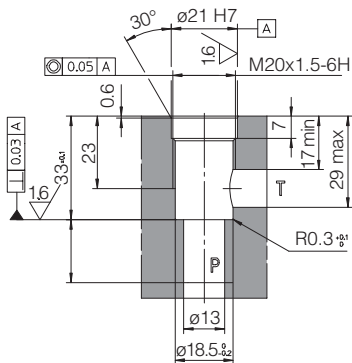

Standard

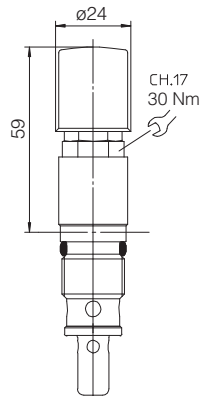

8 CAVITY AND DIMENSIONS FOR CART M-6, CART ARE-15 AND ARE-20 [mm]

