

Stainless steel valves for corrosive environments & water base fluids

ex-proof solenoid valves, Multicertification ATEX, IECEx, EAC or cULus certification

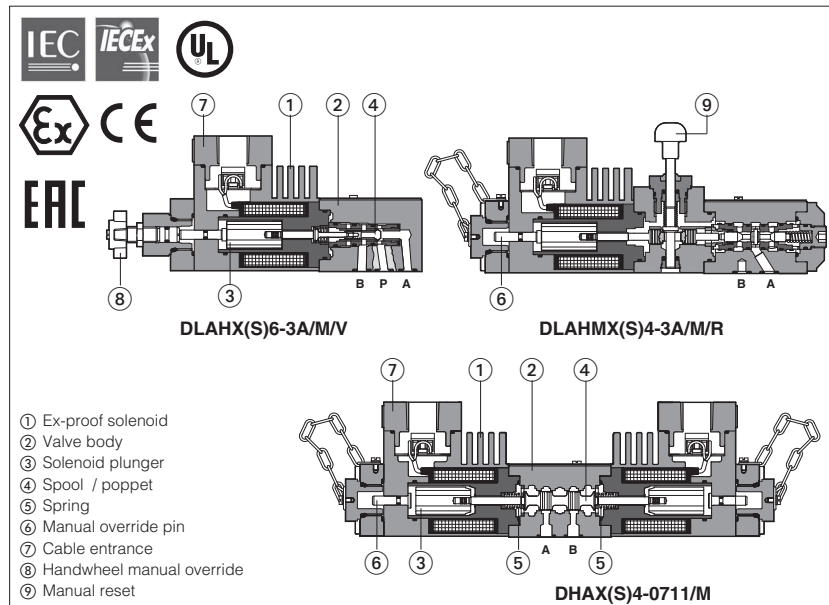

New line of directional solenoid valves and pressure relief valves in stainless steel execution for corrosive environments.

Ex-proof Stainless steel solenoids (1), with **ATEX, IECEx, EAC Multicertification** or **cULus** North American certification, for hazardous areas - see section 5, 6.

Two executions are available:

- **X** stainless steel for external and internal parts, to withstand extreme and corrosive environmental conditions, and to ensure full compatibility also with water base and special fluids.
- **XS** stainless steel for external parts to withstand extreme and corrosive environmental conditions. Internal components are derived from standard valves.

Directional valves are available in two basic versions: poppet type, 3-way leak free (suitable for accumulator systems) or spool type, 4-way on-off valves.

DHAX(S) and DLAHX(S) valves are **SIL** compliance with IEC 61508 (TÜV certified) - see section 1.1

1 STAINLESS STEEL VALVES: MAIN DATA

Valve execution (1)		Description	ISO size	Voltages		ATEX, IECEx		cULus		Max flow l/min	Δp (at max flow) bar	Max pressure bar (3)
X (5)	XS			DC	AC 50/60Hz	T class (2)	Input Power	T class (2)	Input Power			
DHAX4	DHAXS6 DHAXS4	4 way, spool type direct solenoid valves	06 (ISO4401)	12 24 48 110 220	12 24 110 230	T6, T4 T4, T3	8 W 25 W	T6, T5 T3	12 W 33 W	60 70	see diagram at section 1.1	350
DLAHX6 DLAHX4	DLAHXS6 DLAHXS4	3 way, poppet type, direct solenoid valves	06 (ISO4401)			T6, T4 T4, T3	8 W 25 W	T6, T5 T3	12 W 33 W	10 12		315 350
DLAHMX4	DLAHMXS6 DLAHMXS4	3 way, poppet type, direct solenoid valves	06 (ISO4401)			T6, T4 T4, T3	8 W 25 W	T6, T5 T3	12 W 33 W	25 30		250 315
DLAHPX6	DLAHPXS6	3 way, poppet type, piloted solenoid valve	06 (ISO4401)			T6, T4	8 W	-	12 W	40		315
DLAPX6	DLAPXS6	3 way, poppet type, piloted solenoid valve	no			T6, T4	8 W	(2)	12 W	220		315
DLHPX	DLHPXS	3 way, poppet type, hydraulic operated valve	06 (ISO4401)			-	-	-	-	40		315
DLPX	DLPXS	3 way, poppet type, hydraulic operated valve	no			-	-	-	-	220		315
CART-MX-3 CART-MX-6 CART AREX-20	CART-MXS-3 CART-MXS-6 CART AREXS-20	relief valve direct screw-in	no no no	- - -	- - -	- - -	- - -	- - -	2,5 40 (60 PED) 120 (150 PED)	30	420 500 400	
HMPX-*	HMPXS-*	relief valve direct modular	06 (ISO4401)	-	-	-	-	-	40	35	350	
SC LIX-2531* LIMMX-2*	LIMMXS-2*	relief valve DIN cartridge (4)	25 (ISO7368)	-	-	-	-	-	400	6	350	

Notes:

- (1) **XS6** and **XS4** versions differ only for the coil power (see Input Power)
- (2) Solenoid temperature class see section 3
- (3) Max pressure on **T** port = **110 bar**
- (4) Optional electrohydraulic venting available on request.
- (5) The "X" valves in full stainless steel execution are factory tested by Atos with mineral oil or pure water in order to avoid the contamination of the end user system. At the end of each valve model code must be specified the type of fluid to be used in the valve's testing: "H" for hydraulic oil or "W" for pure water.

Ambient temperature:

Valves are provided by HNBR seals, which allow min ambient temperature down to -40 °C (max oil viscosity = 380 cSt). The min ambient temperature for valves with /PE option (FKM seals) is -20°C. Max ambient temperature for valves without solenoids is 70°C. For PED certified pressure relief cartridges see section 9.2

1.1 SIL compliance with IEC 61508: 2010

DHAX(S), DLAHX(S) meets the requirements of:

- **SC3** (systematic capability)
- max **SIL 2** (HFT = 0 if the hydraulic system does not provide the redundancy for the specific safety function where the component is applied)
- max **SIL 3** (HFT = 1 if the hydraulic system provides the redundancy for the specific safety function where the component is applied)

2 MATERIALS SPECIFICATION

Valve type	solenoid housing ①	valve body ②	internal parts for X execution ③ + ④	internal parts for XS execution ③ + ④	spring ⑤	seals	
						std	/PE
DHAX(S)	AISI 630	AISI 316L	AISI 316L, 420B, 440C, 430F	Carbon steel	AISI 302	HNBR (buna)	FKM (viton)
DLAHX(S) DLAHMX(S)	AISI 630	AISI 316L	AISI 316L, 420B, 440C, 430F	Carbon steel	AISI 302	HNBR (buna)	FKM (viton)
DLAHPX(S)	AISI 630	AISI 630	AISI 316L, 420B, 440C, 430F	Carbon steel	AISI 302	HNBR (buna)	FKM (viton)
DLHPX(S)	-	AISI 630	AISI 420B	Carbon steel	AISI 302	HNBR (buna)	FKM (viton)
DLAPX(S)	AISI 630	AISI 630	AISI 316L, 420B, 440C, 430F	Carbon steel	AISI 302	HNBR (buna)	FKM (viton)
DLPX(S)	-	AISI 630	AISI 420B	Carbon steel	AISI 302	HNBR (buna)	FKM (viton)
CART-X(S)	-	AISI 316L	AISI 316L, 420B, 630	Carbon steel	AISI 302	HNBR (buna)	FKM (viton)
HMPX(S)	-	AISI 316L	AISI 316L, 420B, 630	Carbon steel	AISI 302	HNBR (buna)	FKM (viton)
LIMMX(S)	-	AISI 316L	AISI 316L, 420B, 630	Carbon steel	AISI 302	HNBR (buna)	FKM (viton)
SC LIX	-	AISI 316L	AISI 630, AISI 420B	-	AISI 302	HNBR (buna)	FKM (viton)

3 EX-PROOF SOLENOIDS: MAIN DATA

VALVE TYPE		DHAXS6 DLAHX6 DLAHS6 DLAPXS6	DLAHMXS6 DLAHPXS6 DLAPX6 DLAHPX6	DHAX4 DHAXS4 DLAHMX4 DLAHX4	DLAHXS4 DLAHMXS4
Solenoid code	Multicertification	OAX/WP, OAXS/WP		OAKX/WP, OAKXS/WP	
	cULus	OALX/WP, OALXS/WP		OAKULX/WP, OAKULXS/WP	
Voltage code	V _{dc} ±10%	12DC, 24DC, 48DC (1), 110DC, 125DC (1), 220DC			
	VAC 50/60 Hz ±10%	12AC, 24AC, 110-120AC, 230-240AC			
Power consumption	Multicertification	8W		25W	
	cULus	12W		33W	
Coil insulation		Class H			
Protection degree		IP 66/67 According to IEC 60529 when correctly coupled with the relevant cable gland PAXMC/M			
Duty factor		100%			
Mechanical construction	Multicertification	Flame proof housing classified Ex d, according to EN 60079-0: 2006, EN 6079-1: 2007			
	cULus	Flame proof housing classified according to UL 1203 and UL429, CSA 22.2 n°30-1986 and CSA 22.2 n°139-13			
Cable entrance and electrical wiring		Internal terminal board for cable connection threaded connection for cable entrance vertical (standard) or Horizontal (option /O)			
Method of protection		Ex d			
Multicertification	Temperature class	T6 (≤ 85°C)	T4 (≤ 135°C)	T4 (≤ 135°C)	T3 (≤ 200°C)
	Ambient temperature	-40 ÷ +45 °C	-40 ÷ +70 °C	-40 ÷ +45 °C	-40 ÷ +70 °C
cULus	Temperature class	T6 (≤ 85°C)	T5 (≤ 100°C)	T3 (≤ 200°C)	
	Ambient temperature	-40 ÷ +55 °C	-40 ÷ +70 °C	-40 ÷ +70 °C	

Notes: (1) 48DC and 125DC only for Multicertification

For alternating current supply a rectifier bridge is integrated in the solenoid

4 MAIN CHARACTERISTICS, SEALS AND HYDRAULIC FLUIDS - for other fluids not included in below table, consult our technical office





Assembly position / location	Any position for all valves		
Subplate surface finishing	Roughness index Ra 0,4 - flatness ratio 0,01/100 (ISO 1101)		
Seals, recommended fluid temperature	HNBR seals (standard) = -40°C ÷ +60°C, with HFC hydraulic fluids = -40°C ÷ +50°C FKM seals (/PE option) = -20°C ÷ +80°C		
Recommended viscosity	15 ÷ 100 mm ² /s - max allowed range 2.8 ÷ 500 mm ² /s		
Fluid contamination class	ISO 4406 class 21/19/16 NAS 1638 class 10, in line filters of 25 µm (β10 ≥75 recommended)		
Hydraulic fluid	Suitable seals type	Classification	Ref. Standard
Mineral oils	HNBR, FKM	HL, HLP, HLPD, HVLP, HVLPD	DIN 51524
Flame resistant without water	FKM	HFDU, HFDR	ISO 12922
Flame resistant with water	HNBR	HFC	

5 cULus CERTIFICATION

cULus marking

Class I = Equipment for famable gas and vapours
Division 1 = Possibility of explosive atmosphere during normal functioning
Groups C&D = Atmosphere containing flammable gas
Groups IIA&IIB = Gas group
T6/T5 = Temperature class of solenoid surface referred to +55°C / +70°C ambient temperature

EXAMPLE OF NAMEPLATE MARKING

MODEL CODE	0A/EC-24DC		
SERIAL N°	XXXXXXXXXX		
Class I, Groups C & D		T. class T6/T5	
Class I, Groups IIA & IIB		T. class T6/T5	
Max ambient temp.		55/70 °C 131/158 °F	
Electrical rating :		24 V DC 12W	
<p>CAUTION: To reduce the risk of ignition of hazardous atmospheres, disconnect from circuit before opening enclosure. Keep tightly closed when in operation.</p> <p>ATTENTION: Pour réduire le risque d'allumage des atmosphères dangereuses, déconnecter le circuit avant d'ouvrir le boîtier. Garder le bien fermé lorsqu'il est en fonctionnement</p>			
Marking according to UL Directive			
Notified body and certificate number			

6 MULTICERTIFICATION ATEX, IECEX, EAC

In the following are resumed the valves marking according to multicertifications for Group II and Group I (mining)

GROUP II, ATEX, marking

- II 2 G** = Solenoid for surface plants with gas and vapors environment, category 2, suitable for zone 1 and zone 2
- Ex d** = Explosion-proof equipment
- II C** = Equipment of group IIC suitable for substances (gas) of group IIC
- T6/T4** = Solenoid temperature class (maximum surface temperature)
- Gb** = Equipment protection level, high level protection for explosive Gas atmospheres
- CE** = Mark of conformity to the applicable European directives
- II 2 D** = Solenoid for surface plants with dust environment, category 2, suitable for zone 21 and zone 22
- Ex d** = Explosion-proof equipment
- III C** = Suitable for conductive dust (applicable also IIIB and/or IIIA)
- IP66/67** = Protection degree
- T85/T135** = Maximum surface temperature (Dust)
- Db** = Equipment protection level, high level protection for explosive Dust atmospheres
- Ex** = Mark of conformity to the 94/9/CE directive and to the technical norms

GROUP II, IECEX marking

- Ex d** = Explosion-proof equipment
- IIC** = Equipment of group IIC suitable for substances (gas) of group IIC
- T6/T4** = Solenoid temperature classes (Gas)
- Gb** = Equipment protection level, high level protection for explosive Gas atmospheres
- Ex tb** = Equipment protection by enclosure "tb"
- IIIC** = Suitable for conductive dust (applicable also IIIB and/or IIIA)
- T85°C/T135°C** = Maximum surface temperature (Dust)
- Db** = Equipment protection level, high level protection for explosive Dust atmospheres
- IP66/67** = Protection degree

6.1 EAC marking

EAC (EurAsian certification) acknowledges the whole ATEX Directive 2014/34/EU. This certification is available only for gas environment (not for dust).

- II 2 G** = Solenoid for surface plants with gas and vapors environment, category 2, suitable for zone 1 and zone 2
- Ex d** = Explosion-proof equipment
- II C** = Equipment of group IIC suitable for substances (gas) of group IIC
- T6/T4** = Solenoid temperature class (maximum surface temperature)
- Ex** = Mark of conformity to the 94/9/CE directive and to the technical norms

EXAMPLE OF NAMEPLATE MARKING

Atex notified body and certificate number	MODEL N° SERIAL N°	 Atos s.p.a. - Via alta Piano, 57 21019 Sesto Calende (Vai) Italy
Marking according to ATEX Directive	CE	0722 CESI 02 ATEX 014X
IECEX notified body and certificate number	Ex	II 2D Ex tb IIC T85°C / T135°C Db
Marking according to IECEX Directive	IECEX	CES 10.0010X
EAC notified body and certificate number	EAC	Ex d IIC T6/T4 Gb Ex tb IIIC T85°C / T135°C Db
Marking according to ATEX Directive	TP TC N° TC RU C-IT. Г Б08. В. 01784 012/2011 Серия RU N 0408158 Supply <input type="text"/> W <input type="text"/> V <input type="text"/> Hz Tamb. - <input type="text"/> ÷ + 45°C / +70°C IP66/67	
	For the correct selection of connecting cable temperatures see safety instructions	
	AT-907/BT	

7 SPOOL TYPE DIRECTIONAL SOLENOID VALVES: MODEL CODE

DHA	X	4	*	- 0	63	1/2	/ M /	V	24DC	** /	*	/	*
spool type - direct													
X = Stainless steel execution for all parts XS = Stainless steel execution for external parts													
Temperature class, see section 1 4 = T4 6 = T6 (only for XS execution)													
Certification type - = omit for Multicertification /UL = cULus certification													
Size: 0 = 06													
Valve configuration, see section 7.1 61, 63, 71, 75 (configurations 63 and 75 are available only with spool type 1/2)													
Spool type, see section 7.1													
Test fluid, only for X execution: H = mineral oil W = pure water													
Seals material, see section 4: - = HNBR PE = FKM													
Series number													
Voltage code - see section 3													
Options: A = solenoid at side of port B V = with handwheel manual override O = horizontal cable entrance													
Solenoid threaded connection for cable gland: M = M20x1,5 UNI-4535 (6H/6g) for Multicertification NPT = 1/2" NPT ANSI/ASME B46.1 (tapered) for /UL													

7.1 Hydraulic configuration

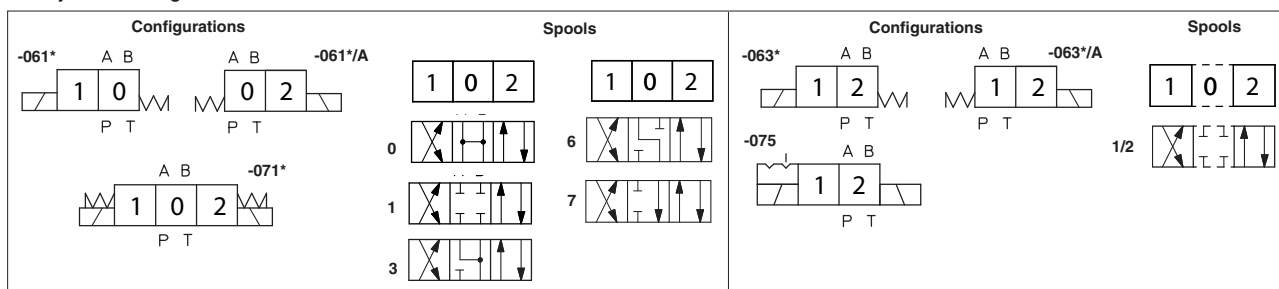

8 POPPET TYPE LEAK FREE DIRECTIONAL SOLENOID VALVES: MODEL CODE

DLAH	X	6	*	-	3	A	/	M	/	V	24DC	**	/	*	/	*
<p>DLAH = direct (10 l/min) DLAHM = direct (25 l/min) DLHP = hydraulic operated DLAHP = solenoid piloted DLP = hydraulic operated DLAP = solenoid piloted</p> <p>X = Stainless steel execution for all parts XS = Stainless steel execution for external parts</p> <p>Temperature class (not for DLHP and DLP) see sect. 11 4 = T4 6 = T6</p> <p>Certification type - = omit for Multicertification /UL = cULus certification</p> <p>3 = three way</p>														<p>Test fluid, only for X execution: H = mineral oil W = pure water</p> <p>Seals material, see section 4: - = HNBR PE = FKM</p> <p>Series number</p>		
<p>Options: (not for DLHP, DLP) R = solenoid manual reset (not combinable with /V) V = handwheel manual override (not combinable with /R) O = Horizontal cable entrance</p> <p>Only for DLAP D = internal drain E = external pilot pressure</p>												<p>Solenoid threaded connection for cable gland: M = M20x1,5 UNI-4535 (6H/6g) for Multicertification NPT = 1/2" NPT ANSI/ASME B46.1 (tapered) for /UL</p>				
<p>Valve configuration, see section 8.1 A = A (B) to T in rest position C = P to A (B) in rest position</p>																

8.1 Hydraulic configuration

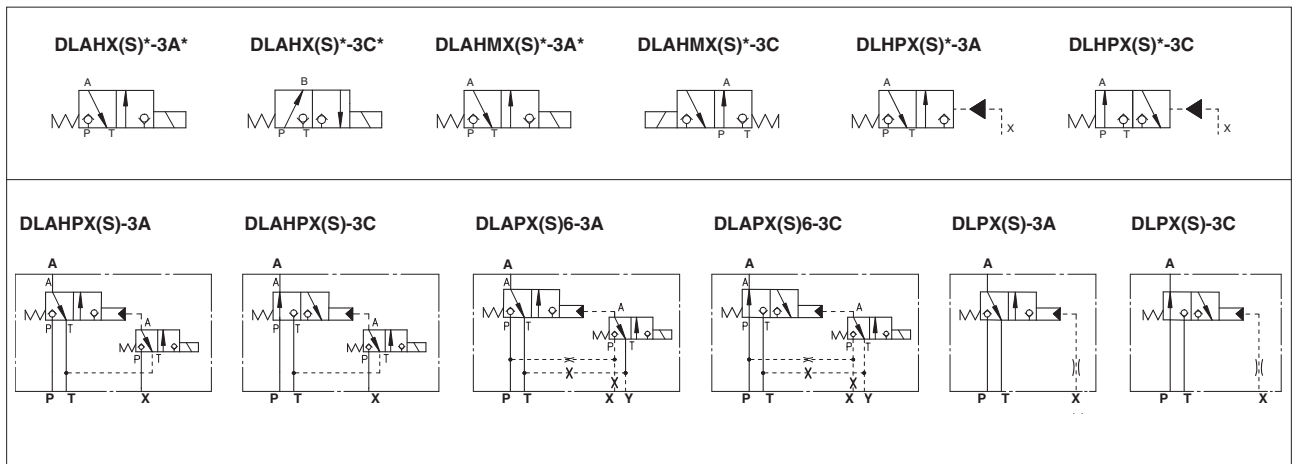

9 PRESSURE CONTROL VALVES: MODEL CODE

9.1 Screw-in type, STANDARD versions

CART	MX-3	/	350	/	**	/	*	/	*
Screw-in relief cartridge									
See note (1): MX(S)-3 = G1/2 MX(S)-6 = M33x1,5 AREX(S)-20 =M35x1,5									Test fluid, only for X execution: H = mineral oil W = pure water
Pressure range: see max pressure setting in section 9.3					Series number		Seals material, see section 4: - = HNBR PE = FKM		

(1): **X** = Stainless steel execution for all parts
XS = Stainless steel execution for external parts

9.2 Screw-in type, PED CERTIFIED versions

CART	MX-3	/	420	/	PED	/	*	/	**	/	*	/	*
Screw-in relief cartridge													
See note (1): MX(S)-3 = G1/2 MX(S)-6 = M33x1,5 AREX(S)-20 =M35x1,5									Series number		Seals material, see section 4: - = HNBR PE = FKM		Test fluid, only for X execution: H = mineral oil W = pure water
Max pressure setting see max pressure setting in section 9.3													
													* = factory pressure setting to be defined by the customer min step: 1bar - (example 280 = 280 bar) min pressure setting: 25 bar for MX(S) cartridges 30 bar for AREX(S) cartridge
													PED = certified by DEKRA according to 2014/68/EU (2)

(1) **X** = Stainless steel execution for all parts
XS = Stainless steel execution for external parts
(2) For PED certified cartridges the min ambient / fluid temperature is:
-40°C for CART MX(S)-3 and CART MX(S)-6
-20°C for CART AREX(S)-20
-20°C for all cartridges with /PE option (FKM seals)

9.3 Hydraulic characteristics

Valve model		CART MX(S)-3					CART MX(S)-6					CART AREX(S)-20		
Max pressure setting [bar]	STANDARD	50	100	210	350	420	50	100	210	350	500	50	100	210
	PED			420					420			315	400	
Pressure range [bar]	STANDARD (1)	4÷50		6÷100	7÷210		2÷50	3÷100	8÷210		3÷50	5÷100	6÷210	
	PED			8÷350	15÷420		15÷350		15÷500		8÷315		10÷400	
Max pressure on port T [bar]	(2)	50					50					50		
Max flow [l/min]	STANDARD	2,5					40					120		
	PED	2,5					60					150		

(1) The values correspond to the min and max regulation of the valve's craking pressure
(2) Ped valves should be operated without counterpressure on T line

9.2 Modular type

HMP	X	-	011	/	350	**	/	*	/	*
Modular pressure relief valve ISO 4401 size 06						Series number		Seals material, see section 4: - = HNBR PE = FKM		Test fluid, only for X execution: H = mineral oil W = pure water
X = Stainless steel execution for all parts XS = Stainless steel execution for external parts										
Configuration, see section 9.5 011 013 014			Pressure range for HMP: 50 = 50 bar 210 = 210 bar 100 = 100 bar 350 = 350 bar							

9.3 Control cover

LIMM	X	-	2	/	350	**	/	*	/	*
Cover according to ISO 7368						Series number		Seals material, see section 4: - = HNBR PE = FKM		Test fluid, only for X execution: H = mineral oil W = pure water
X = Stainless steel execution for all parts XS = Stainless steel execution for external parts										
Size: 2 = 25			Pressure range 50 = 6 ÷ 50 bar 210 = 10 ÷ 210 bar 100 = 8 ÷ 100 bar 350 = 15 ÷ 350 bar							

9.4 Standard cartridge valve to be coupled with LIMMX(S) cover

SC LI	X	-	25	31	/	2	**	/	*	/	*
Cartridge according to ISO 7368							Series number		Seals material, see section 4: - = HNBR PE = FKM		Test fluid, only for X execution: H = mineral oil W = pure water
X = Stainless steel execution for all parts											
Size 25											
Area ratio 1÷1											
Note: for LIMMXS cover, the standard SCLI-25* cartridge can be used											
			Spring cracking pressure 1 = 0,3 bar 3 = 3 bar 2 = 1,2 bar 6 = 6 bar								

9.5 Hydraulic configuration

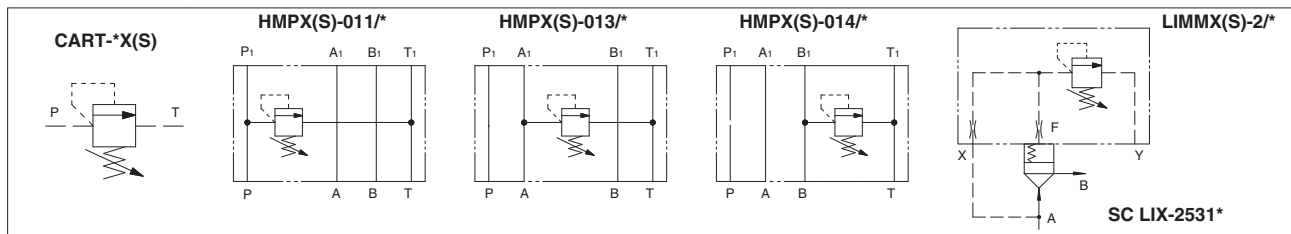

10 CABLE GLANDS AND WIRING

10.1 Cable glands - only for Multicertification

Cable glands with threaded connections M20x1,5 for standard or armoured cables have to be ordered separately, see tech. table **K600**

10.2 Ex proof solenoid wiring

Multicertification

Standard version **Option /O**

- ① cover with threaded connection for vertical cable gland fitting
- ② cover with threaded connection for horizontal cable gland fitting
- ③ terminal board for cables wiring
- ④ screw terminal for additional equipotential grounding
- ⑤ standard manual override

1	Coil +
2	GND
3	Coil -

PCB 3 poles terminal board
suitable for wires cross sections
up to 2,5 mm² (max AWG14)

Power supply: section of coil connection wires = 2,5 mm²

Grounding: section of internal ground wire = 2,5 mm²
section of external ground wire = 4 mm²

Wiring specifications

Power supply: section of coil connection wires = 2,5 mm²
Grounding: section of internal ground wire = 2,5 mm²

The additional equipotential grounding can be also performed by the user on the external facility provided on the solenoid case.
Section of external ground wire = 4 mm²

cULus certification

Standard version **Option /O**

- ① cover with threaded connection for vertical cable gland fitting
- ② cover with threaded connection for horizontal cable gland fitting
- ③ terminal board for cables wiring
- ④ standard manual override

1	Coil +
2	GND
3	Coil -

PCB 3 poles terminal board
suitable for wires cross sections
up to 2,5 mm² (max AWG14)

(2) = alternative GND screw terminal
connected to solenoid housing

Cable Specification:
Power supply and transducer cables have to comply with following characteristics

- Suitable for use in Class I Division 1, Gas Groups C
- Armored Marine Shipboard Cable which meets UL 1309
- Tinned Stranded Copper Conductors
- Bronze braided armor
- Overall impervious sheath over the armor

Any Listed (UBVZ/ UBVZ7) Marine Shipboard Cable rated 300 V min, 15A min. 3C 2,5 mm² (14 AWG) having a suitable service temperature range of at least -25°C to +110°C ("BT" Models require a temperature range from -40°C to +110°C)

For Class I wiring the 3C 1,5 mm² AWG 16 cable size is admitted only if a fuse lower than 10 A is connected to the load side of the solenoid wiring.

Note: a Loctite sealant type 545, should be used on the cable gland entry threads

10.3 Cable temperature

The cable must be suitable for the working temperature as specified in the "safety instructions" delivered with the first supply of the products.

For Multicertification

Max ambient temperature [°C]	Temperature class	Surface temperature [°C]	Cable temperature
45 °C	T6	<85 °C	not prescribed
70 °C	T4	<135 °C	90 °C

For cULus

Max ambient temperature [°C]	Temperature class	Surface temperature [°C]	Cable temperature
55 °C	T6	<85 °C	100 °C
70 °C	T5	<100 °C	100 °C

11 Q/Δp DIAGRAMS (based on mineral oil ISO VG 46 at 50°C)

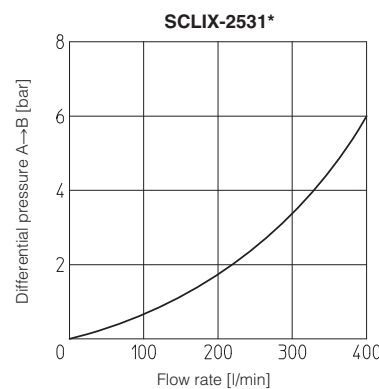
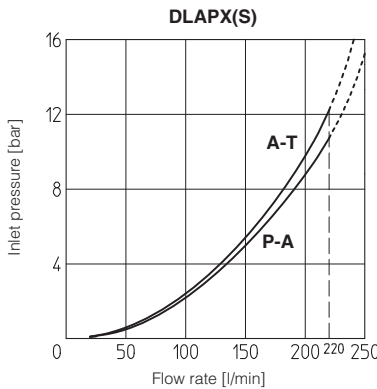
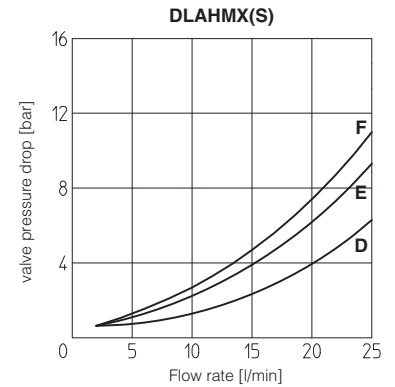
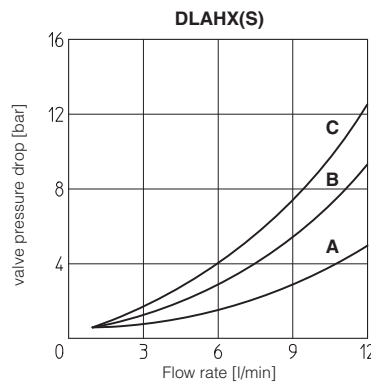
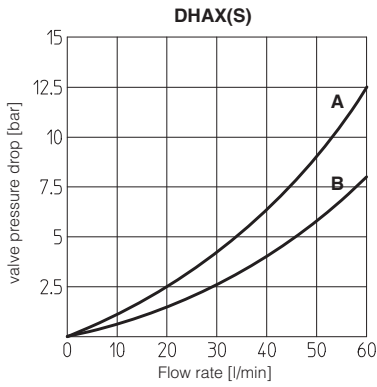

DHAX(S)

Flow direction \ Spool type	P → A		A → T		B → T		P → T	
	P → A	A → T	P → B	B → T	A → T	B → T	P → T	A → T
0	B	B	B	B	B	B	A	A
1, 1/2	A	A	A	A	A	A		
3	A	A	B	B	B	B		
6	A	A	B	B	A	A		
7	A	A	A	B				

Flow direction \ Valve type	P → A (P → B)		A → T (B → T)	
	P → A	P → B	A → T	B → T
DLAHX(S)-3A	C		B	
DLAHX(S)-3C	B		A	
DLAHMX(S)-3A	F		E	
DLAHMX(S)-3C	E		D	

12 OPERATING LIMITS OF ON/OFF DIRECTIONAL CONTROLS (based on mineral oil ISO VG 46 at 50°C)

The diagram have been obtained with warm solenoids and power supply at lowest value ($V_{nom}-10\%$). For DHAX(S) valves the curves refer to application with symmetrical flow through the valve (i.e. P → A and B → T). In case of asymmetric flow the operating limits must be reduced.

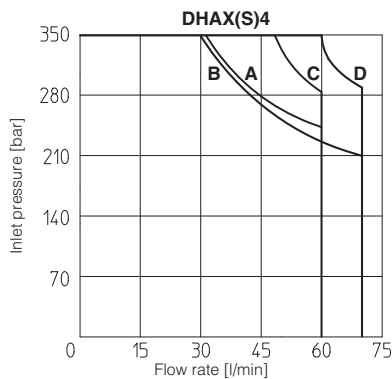

DHAX4 A = Spools 0,1 B = Spools 1/2, 3, 6, 7
DHAXS4 C = Spools 0,1 D = Spools 1/2, 3, 6, 7

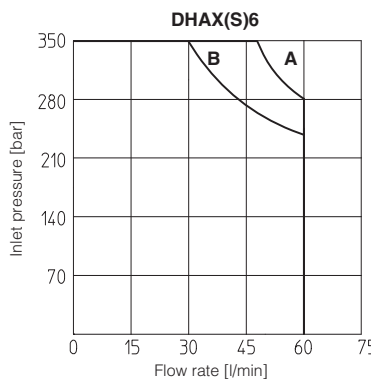

A = Spools 0,1 B = Spools 1/2, 3, 6, 7

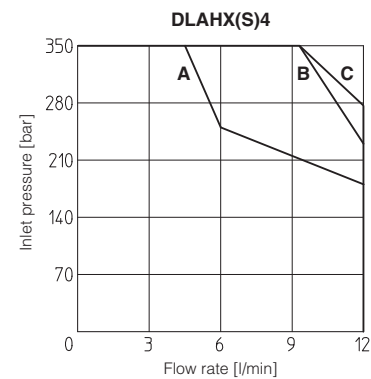

DLAHX4 A = Spool 3C B = Spool 3A
DLAHXS4 C = Spools 3C, 3A

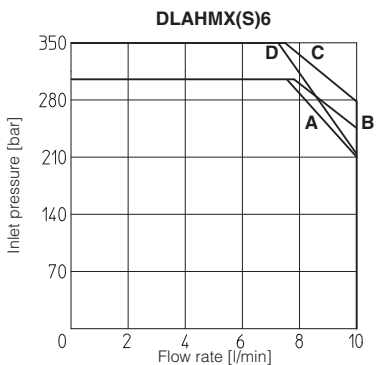

DLAHX6 A = Spool 3A B = Spool 3C
DLAHXS6 C = Spool 3A D = Spool 3C

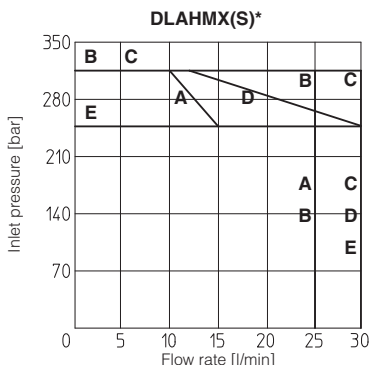

DLAHMX4 A = Spool 3C B = Spool 3A
DLAHMXS4 C = Spool 3A D = Spool 3C
DLAHMXS6 E = Spool 3A, 3C

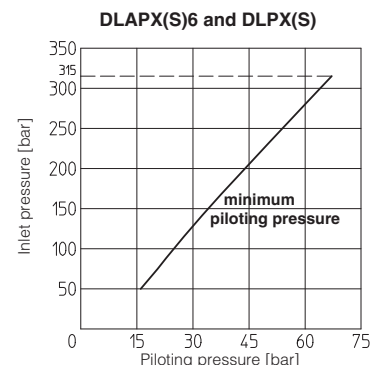

minimum piloting pressure

- 12.1 Internal leakages** for DLAHX(S), DLAHMX(S), DLAHPX(S), DLHPX(S), DLAPX(S) and DLPX(S): less than 5 drops/min (0,36 cm³/min) at max pressure.
- 12.2 Piloting pressure** for DLAPX(S) and DLHPX(S) max piloting pressure = 315 bar; min piloting pressure = 90 bar
for DLAPX(S) and DLPX(S) max piloting pressure = 315 bar; min piloting pressure = see above diagram

13 REGULATED PRESSURE VERSUS FLOW DIAGRAM of screw-in cartridge valves (based on mineral oil ISO VG 46 at 50°C)

13.1 Standard versions

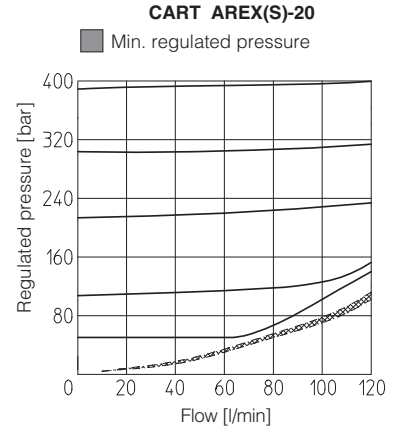
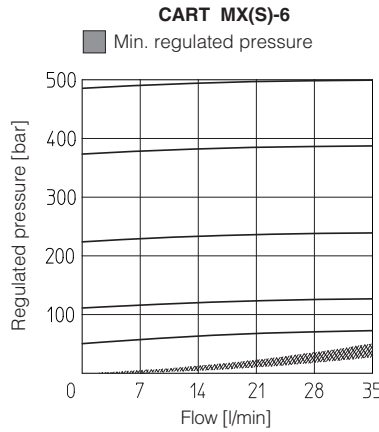
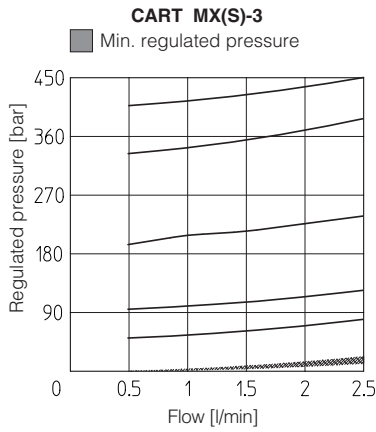

13.2 PED certified versions

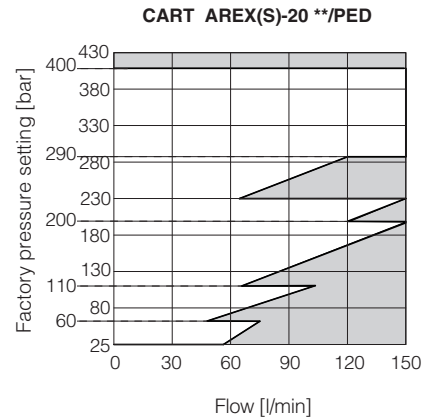
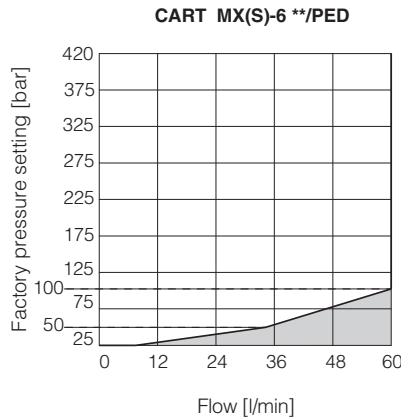
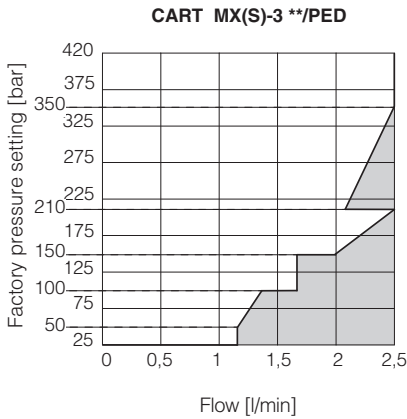

Note:

- 1) The valves can operate only in the white area of the above diagrams.
The maximum flow values within the white area are those for which the pressure increases of +10% respect to the factory pressure setting.
Pressure / flow values located in gray areas cannot be performed
- 2) The working range in above diagrams is valid with 0 bar in T line.
As general rule PED valves should be operated without counter pressure in the T line.
Differently, in case of counter pressure in T line, the maximum flow is reduced respect to values reported in the diagrams.
There is a relation between the maximum counter pressure, the factory pressure setting and the maximum flow: with a flow near to zero, the maximum counter pressure in T line is 10% of the factory pressure setting.
With increasing flow, the maximum counter pressure in T line must be reduced. Contact Atos technical office for details.

14 REGULATED PRESSURE for modular valves

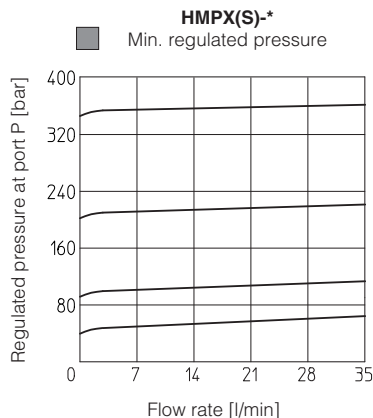

15 INSTALLATION DIMENSIONS OF DHAX(S) [mm]

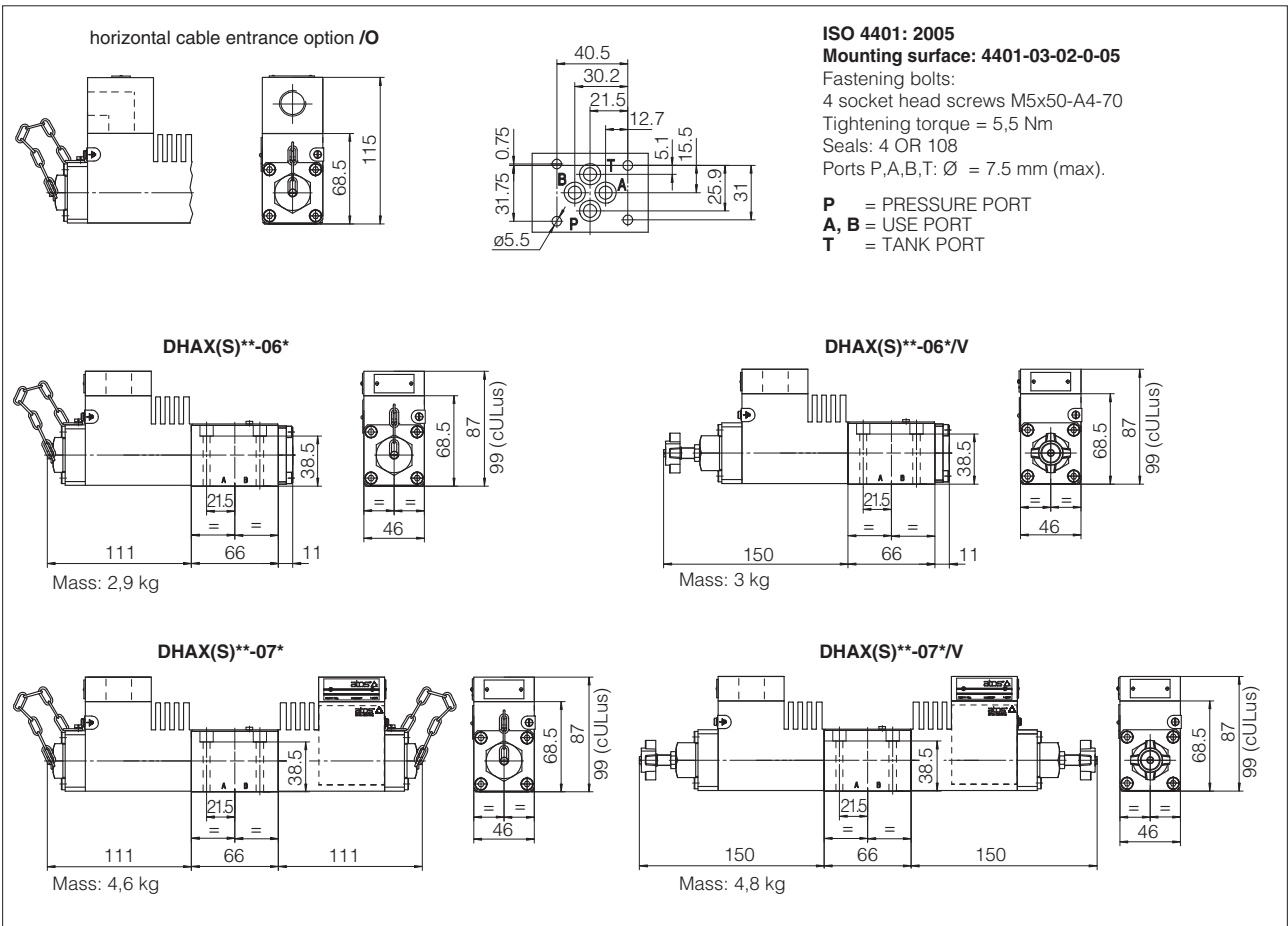

16 INSTALLATION DIMENSIONS OF DLAHX(S) AND DLAHM(S) [mm]

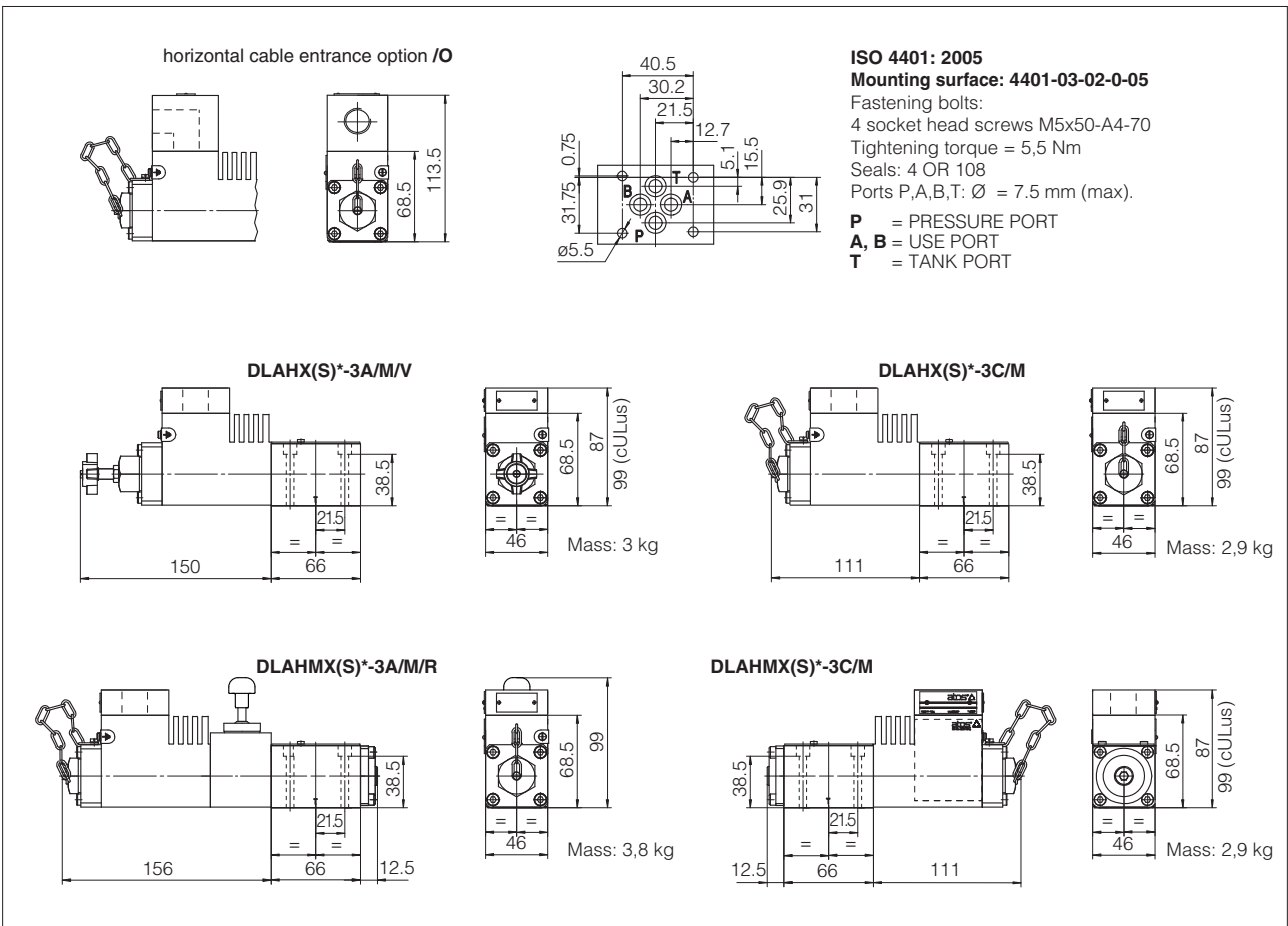

17 INSTALLATION DIMENSIONS OF DLHPX(S) AND DLAHPX(S) [mm]

ISO 4401: 2005

Mounting surface: 4401-03-02-0-05

Fastening bolts:

4 socket head screws M5x75-A4-70

Tightening torque = 5,5 Nm

Seals: 4 OR 108

Ports P,A,B,T: $\varnothing = 7.5$ mm (max).

P = PRESSURE PORT
A = USE PORT
B = not present
T = TANK PORT
X = PILOT PORT

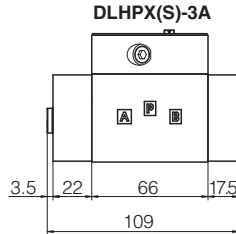
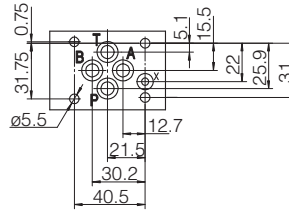

Mass: 5 kg

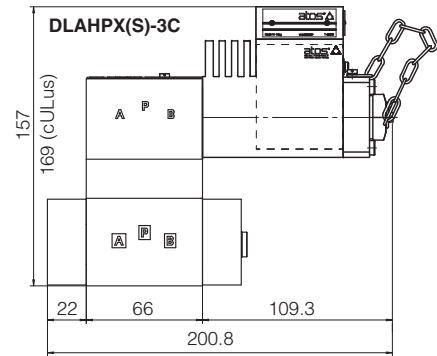
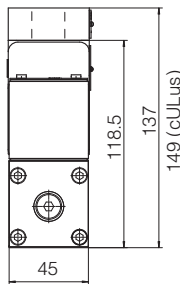
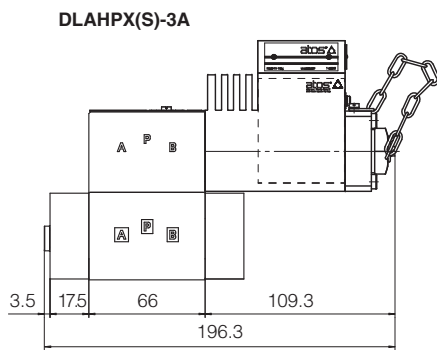
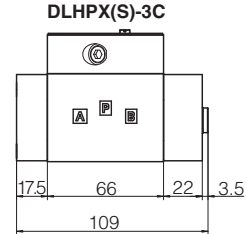
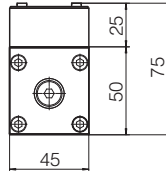

18 INSTALLATION DIMENSIONS OF DLAPX(S) AND DLPX(S) [mm]

Mounting surface DLAPX(S)6 and DLPX(S) not ISO standard

Fastening bolts:

4 socket head screws M10x70-A4-70

Tightening torque = 40 Nm

Seals: 3 OR 3081; 2 OR 108

Ports P,A,T: $\varnothing = 16$ mm (max)

Ports X, Y: $\varnothing = 7$ mm (max)

DLAPX(S)6-3A/M
DLAPX(S)6-3C/M (dotted line)

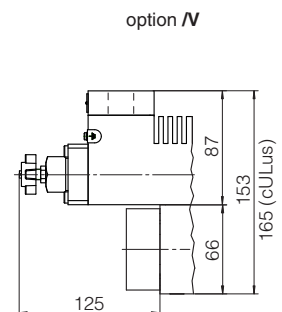
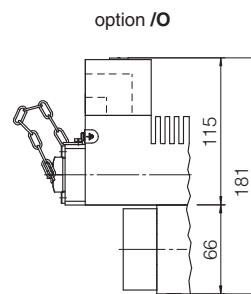
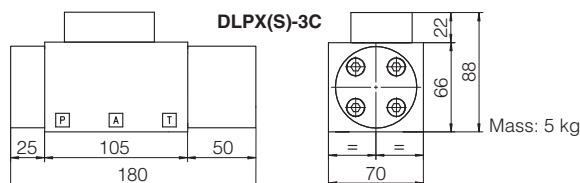
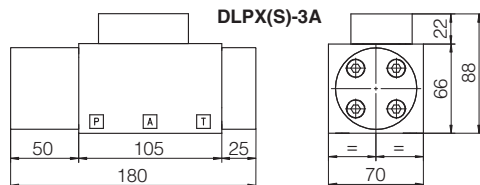
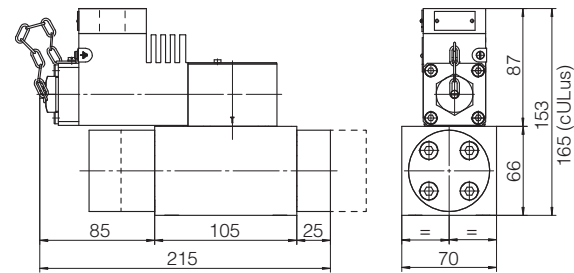
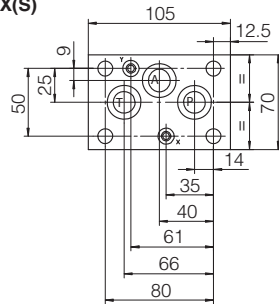

19 INSTALLATION DIMENSIONS OF SCREW IN PRESSURE RELIEF VALVES [mm]

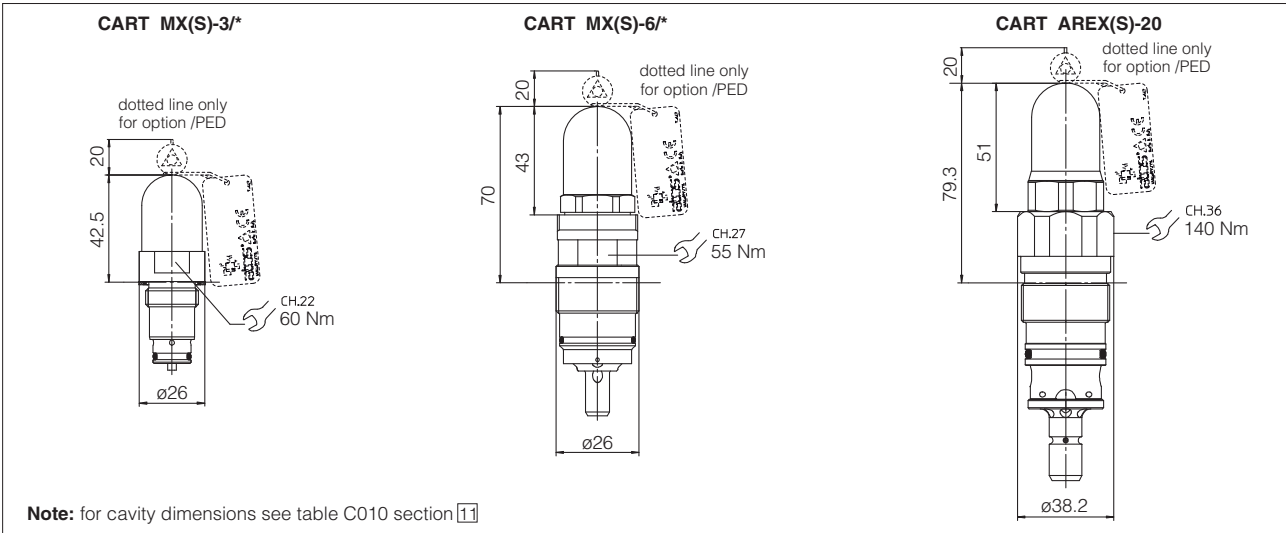

20 INSTALLATION DIMENSIONS OF MODULAR AND CARTRIDGE VALVES

ISO 4401: 2005

Mounting surface: 4401-03-02-0-05

Fastening bolts: M5x**-A4-70

Tightening torque = 5,5 Nm

Seals: 4 OR 108

Ports P,A,B,T: Ø = 7.5 mm (max)

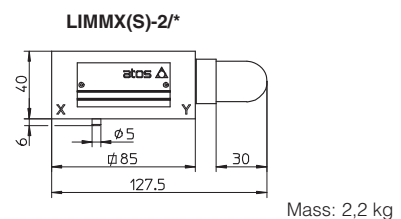
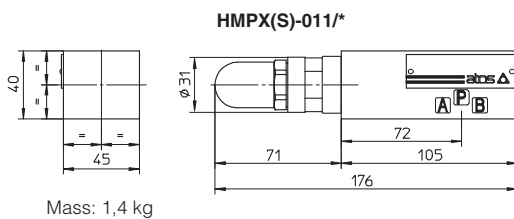
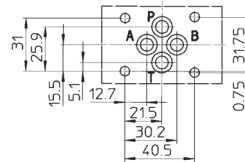

Cover interface dimensions for LIMMX(S)-2

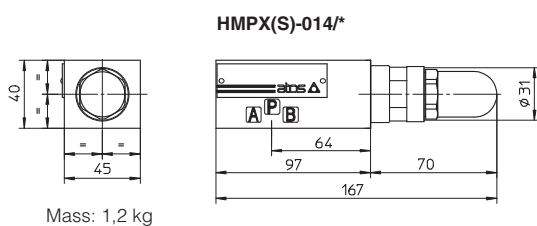
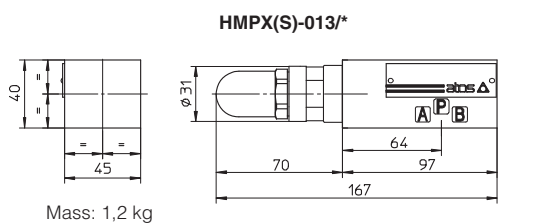
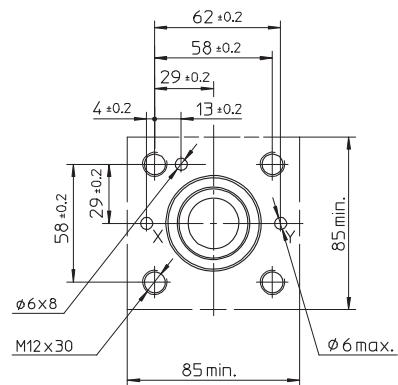

Recess dimensions for SC LIX-25

