



DZCE*G

PRESSURE REDUCING VALVES WITH PROPORTIONAL CONTROL AND INTEGRAL ELECTRONICS

SERIES 31

DZCE5G CETOP P05
DZCE5RG ISO 4401-05
DZCE7G ISO 4401-07
DZCE8G ISO 4401-08

p max **350** bar

Q max (see performance table)

OPERATING PRINCIPLE

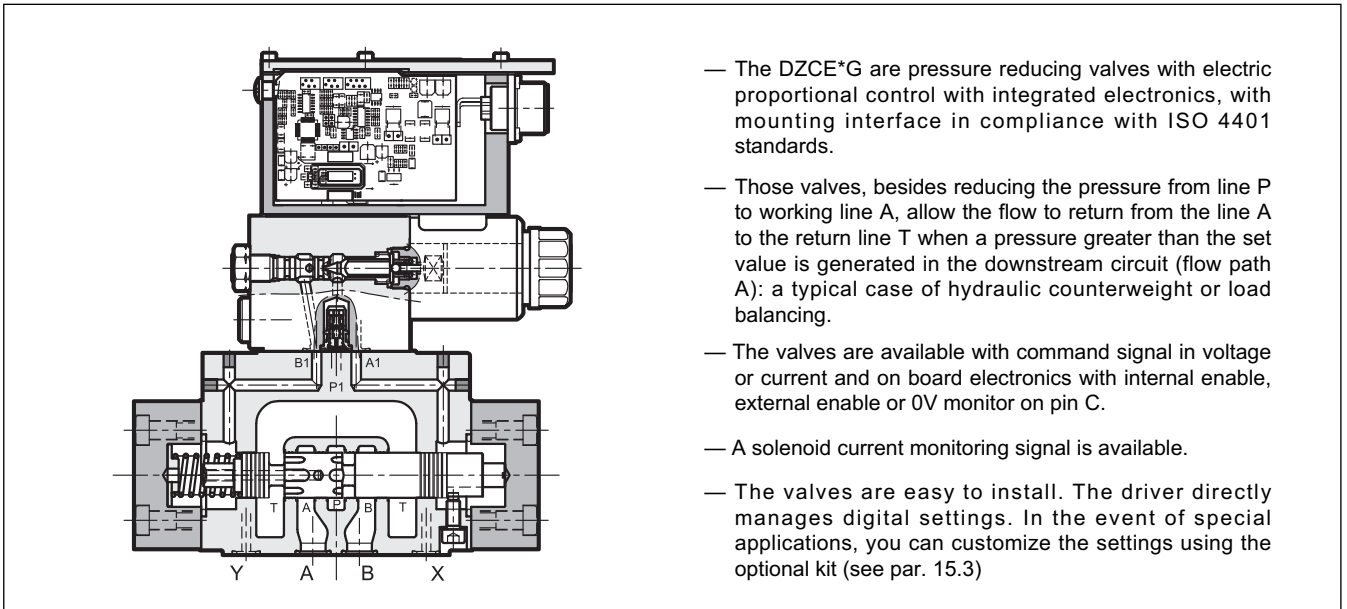

PERFORMANCES

(obtained with mineral oil with viscosity of 36 cSt at 50°C p = 140 bar)

		DZCE5G DZCE5RG	DZCE7G	DZCE8G
Max operating pressure	bar	350		
Maximum flow	l/min	150	300	500
Step response		see paragraph 7		
Hysteresis	% of p _{max}	< 2%		
Repeatability	% of p _{max}	< ±2%		
Electrical characteristics		see paragraph 3		
Ambient temperature range	°C	-20 / +60		
Fluid temperature range	°C	-20 / +80		
Fluid viscosity range	cSt	10 + 400		
Fluid contamination degree		According to ISO 4406:1999 class 18/16/13		
Recommended viscosity	cSt	25		
Mass	kg	7,3	9,5	15,6

HYDRAULIC SYMBOL

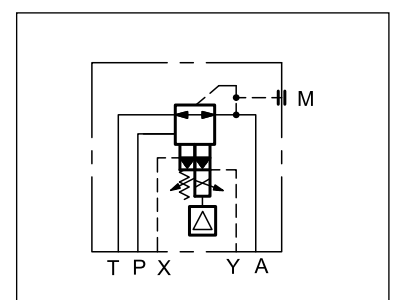

1 - IDENTIFICATION CODE

D	Z	C	E		G	-	/	31	-		/	K11	
----------	----------	----------	----------	--	----------	----------	----------	-----------	----------	--	----------	------------	--

Pressure reducing valve

Electric proportional control

Nominal size:
5 = CETOP P05
5R = ISO 4401-05
7 = ISO 4401-07
8 = ISO 4401-08

Integrated electronics for open loop

Pressure control range:
070 = 1 ÷ 70 bar
140 = 1 ÷ 140 bar
210 = 1 ÷ 210 bar
300 = 1 ÷ 300 bar

Series No.
 (the overall and mounting dimensions remain unchanged from 30 to 39)

Pin C function:
A = external enable
B = internal enable
C = 0V monitor

Main connector
 6 pin + PE

Reference signal:
E0 = voltage 0 ÷ 10 V
E1 = current 4 ÷ 20 mA

Drainage: **I** = internal
E = external

Piloting: **I** = internal
E = external

Seals:
N = NBR seals for mineral oil (standard)
V = FPM seals for special fluids

2 - DETAILED SYMBOL

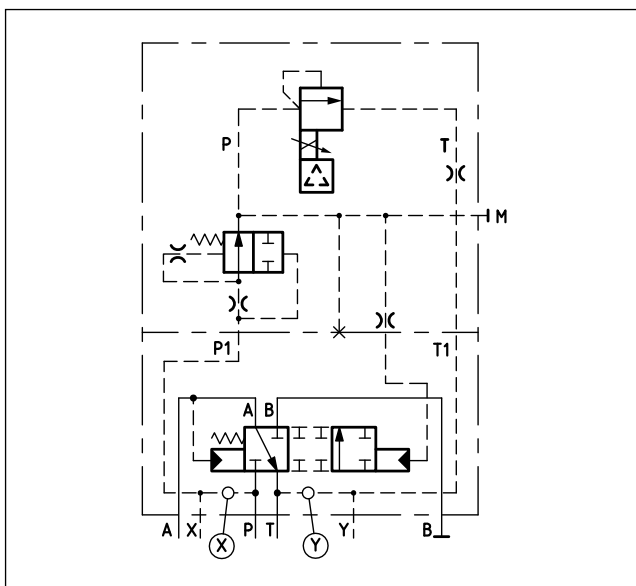

3 - ELECTRICAL CHARACTERISTICS

3.1 - Electrical on board electronics

Duty cycle		100% (continuous operation)
Protection class according to IEC 60529		IP65 / IP67
Supply voltage	V DC	24 (from 19 to 30 VDC), ripple max 3 Vpp
Power consumption	VA	25
Maximum solenoid current	A	1.88
Fuse protection, external		2A time lag
Command signals: voltage (E0) current (E1)	V DC mA	0 ÷ 10 (Impedance Ri > 11 kOhm) 4 ÷ 20 (Impedance Ri = 58 Ohm)
Monitor signal (current to solenoid): voltage (E0) current (E1)	V DC mA	0 ÷ 10 (Impedance Ro > 1 kOhm) 4 ÷ 20 (Impedance Ro = 500 Ohm)
Managed breakdowns		Overload and electronics overheating, cable breakdown, supply voltage failures
Communication		LIN-bus Interface (with the optional kit)
Connection		7 - pin MIL-C-5015-G (DIN-EN 175201-804)
Electromagnetic compatibility (EMC) emissions EN 61000-6-4 immunity EN 61000-6-2		According to 2014/30/EU standards

3.2 - On-board electronics diagrams

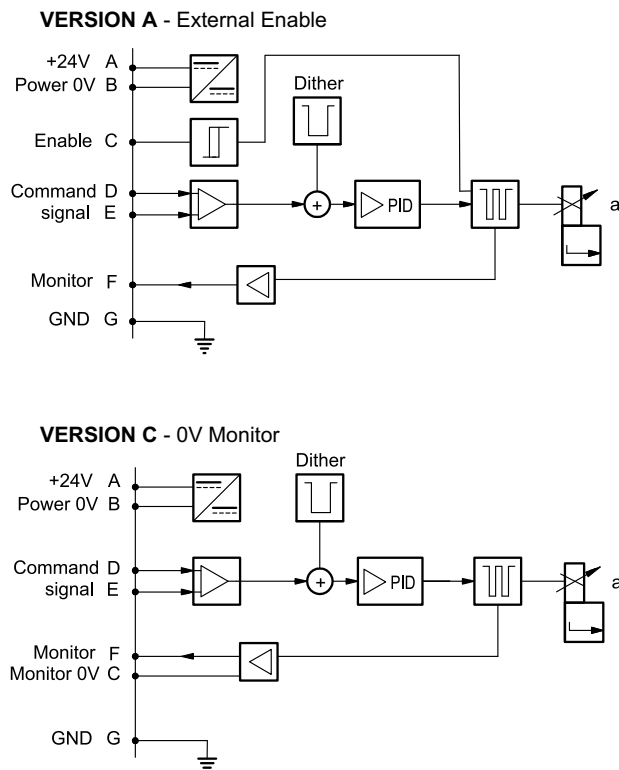

4 - VERSIONS WITH VOLTAGE COMMAND (E0)

The reference signal is between 0 ÷ 10V. The monitor feature of versions B and C becomes available with a delay of 0,5 sec from the power-on of the card.

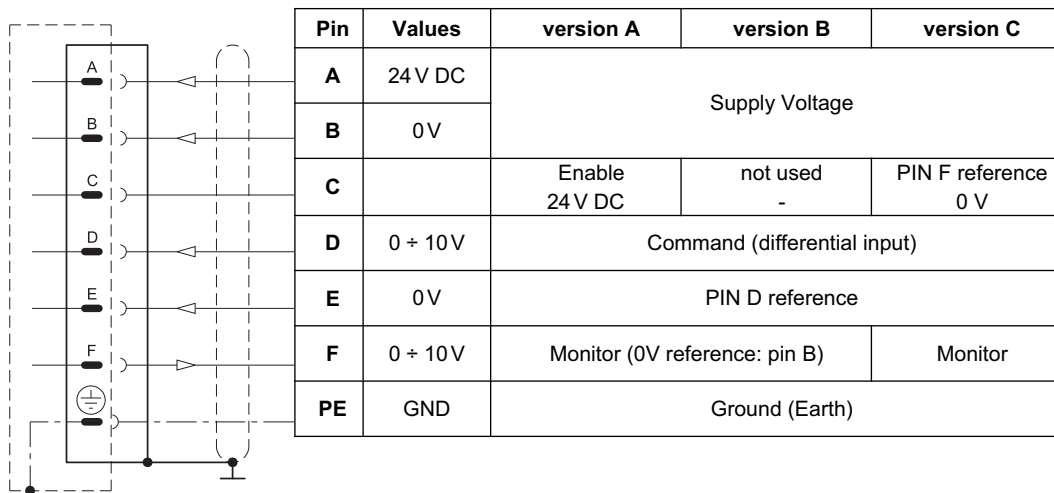
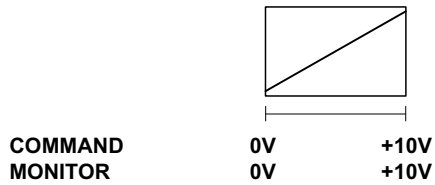

5 - VERSIONS WITH CURRENT COMMAND (E1)

The reference signal is supplied in current 4 ÷ 20 mA. If the current for command is lower, the card shows a breakdown cable error. To reset the error is sufficient to restore the signal.

The monitor feature of versions B and C becomes available with a delay of 0,5 sec from the power-on of the card.

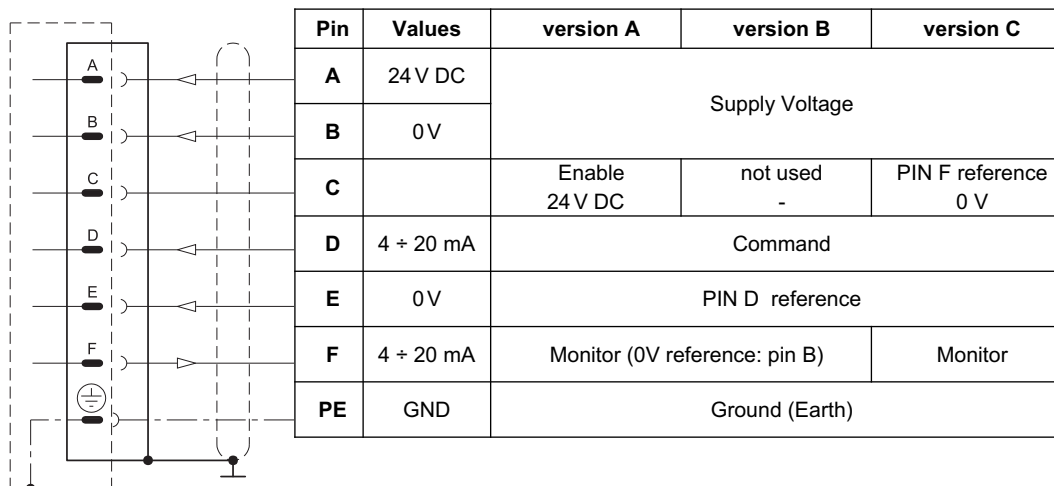
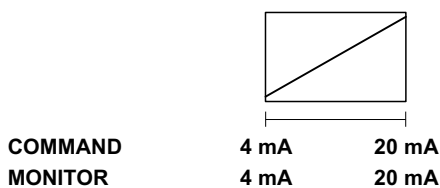



6 - CHARACTERISTIC CURVES

(with mineral oil with viscosity of 36 cSt at 50°C)

6.1 - Characteristic Curves of DZCE5G and DZCE5RG

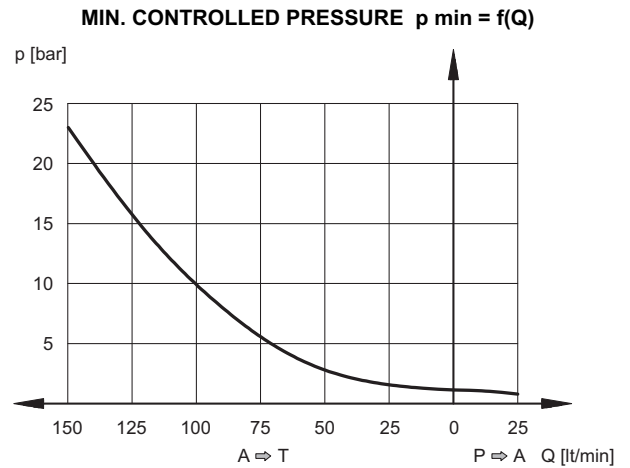
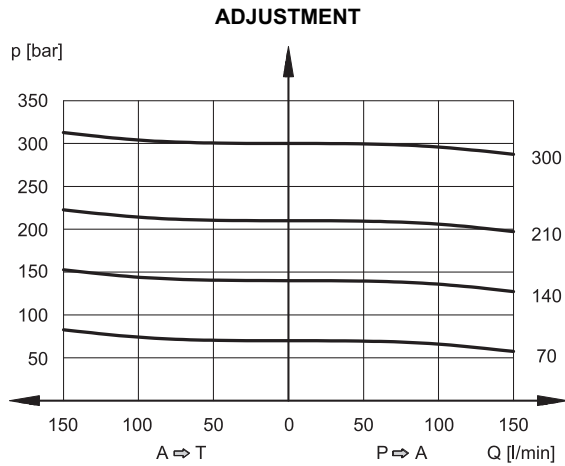

6.2 - Characteristic Curves of DZCE7G

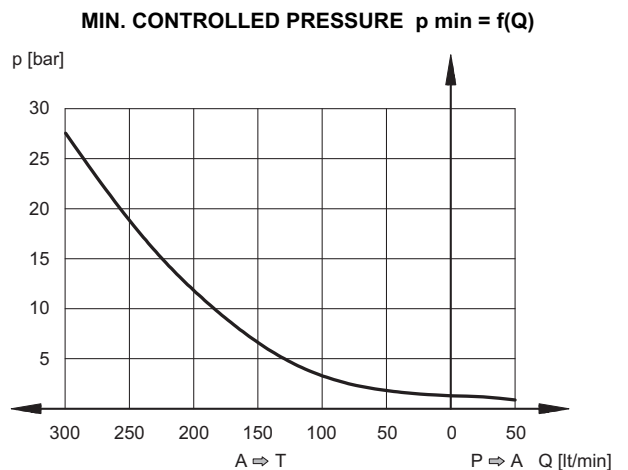
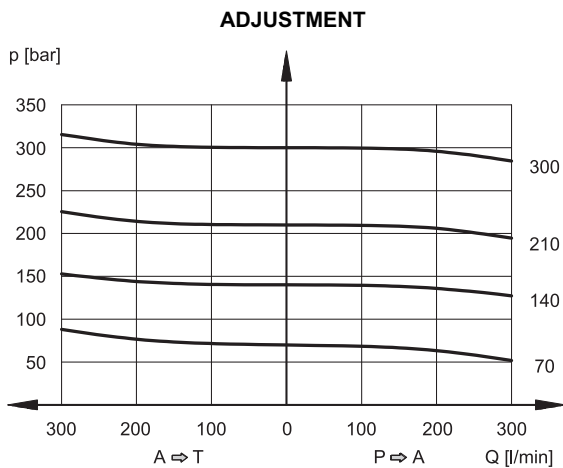

6.3 - Characteristic Curves of DZCE8G

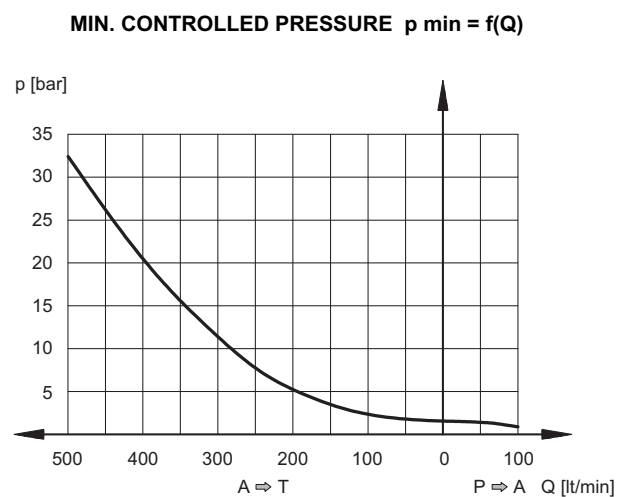
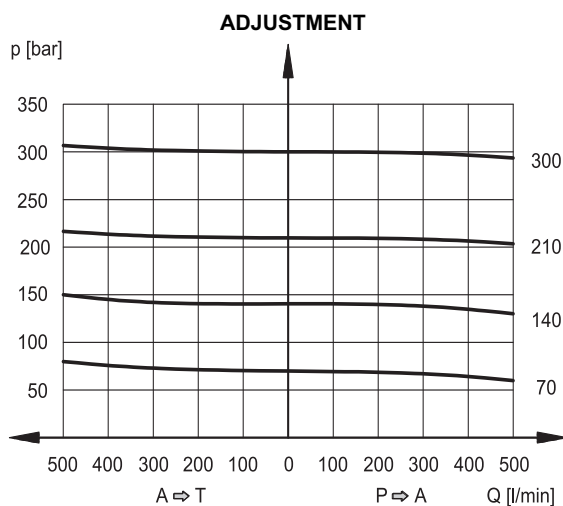



6.4 - CONTROLLED PRESSURE $p = f(I)$

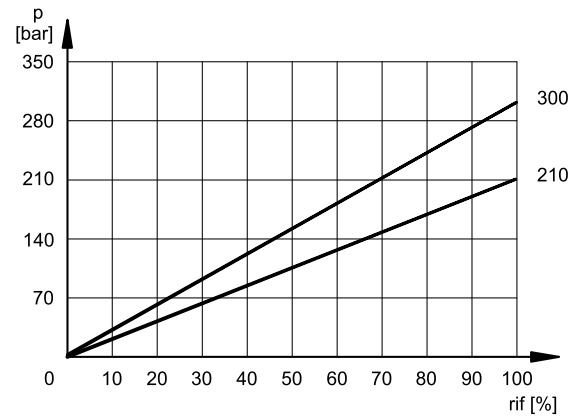
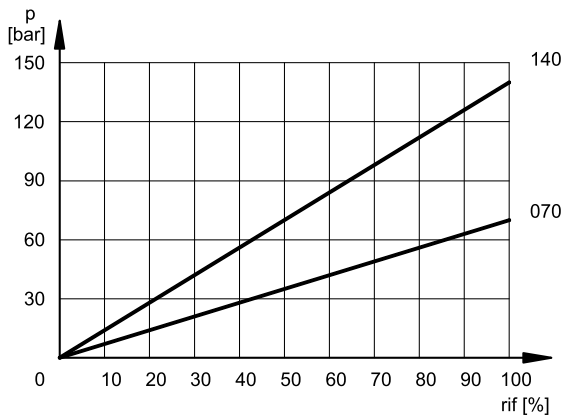

7 - STEP RESPONSE

(obtained with mineral oil with viscosity of 36 cSt at 50°C)

The graphs show the typical step response tested with static pressure 100 bar.

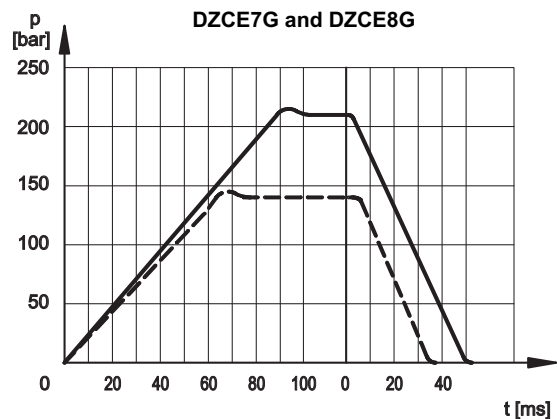
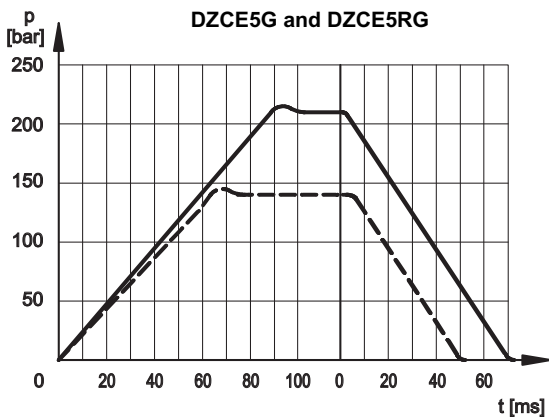

8 - PILOTING AND DRAINAGE

The valves are available with piloting and drainage, both internal and external. The version with external drainage allows a higher backpressure on the unloading.

TYPE OF VALVE	Plug assembly	
	X	Y
IE INTERNAL PILOT AND EXTERNAL DRAIN	NO	YES
II INTERNAL PILOT AND INTERNAL DRAIN	NO	NO
EE EXTERNAL PILOT AND EXTERNAL DRAIN	YES	YES
EI EXTERNAL PILOT AND INTERNAL DRAIN	YES	NO

DZCE5 and DZCE5RG

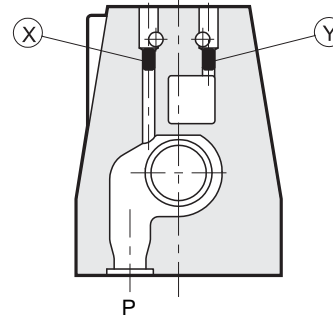

X: M5x6 plug for external pilot
Y: M5x6 plug for external drain

P

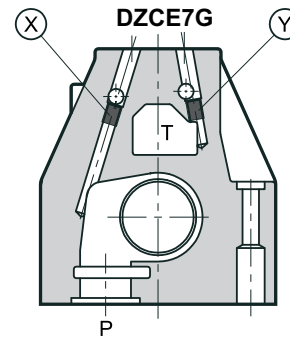

X: M6x8 plug for external pilot
Y: M6x8 plug for external drain

P

DZCE8G

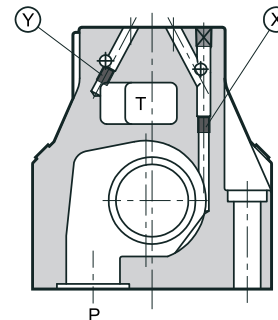

X: M6x8 plug for external pilot
Y: M6x8 plug for external drain

P

9 - OVERALL AND MOUNTING DIMENSIONS DZCE5G AND DZCE5RG

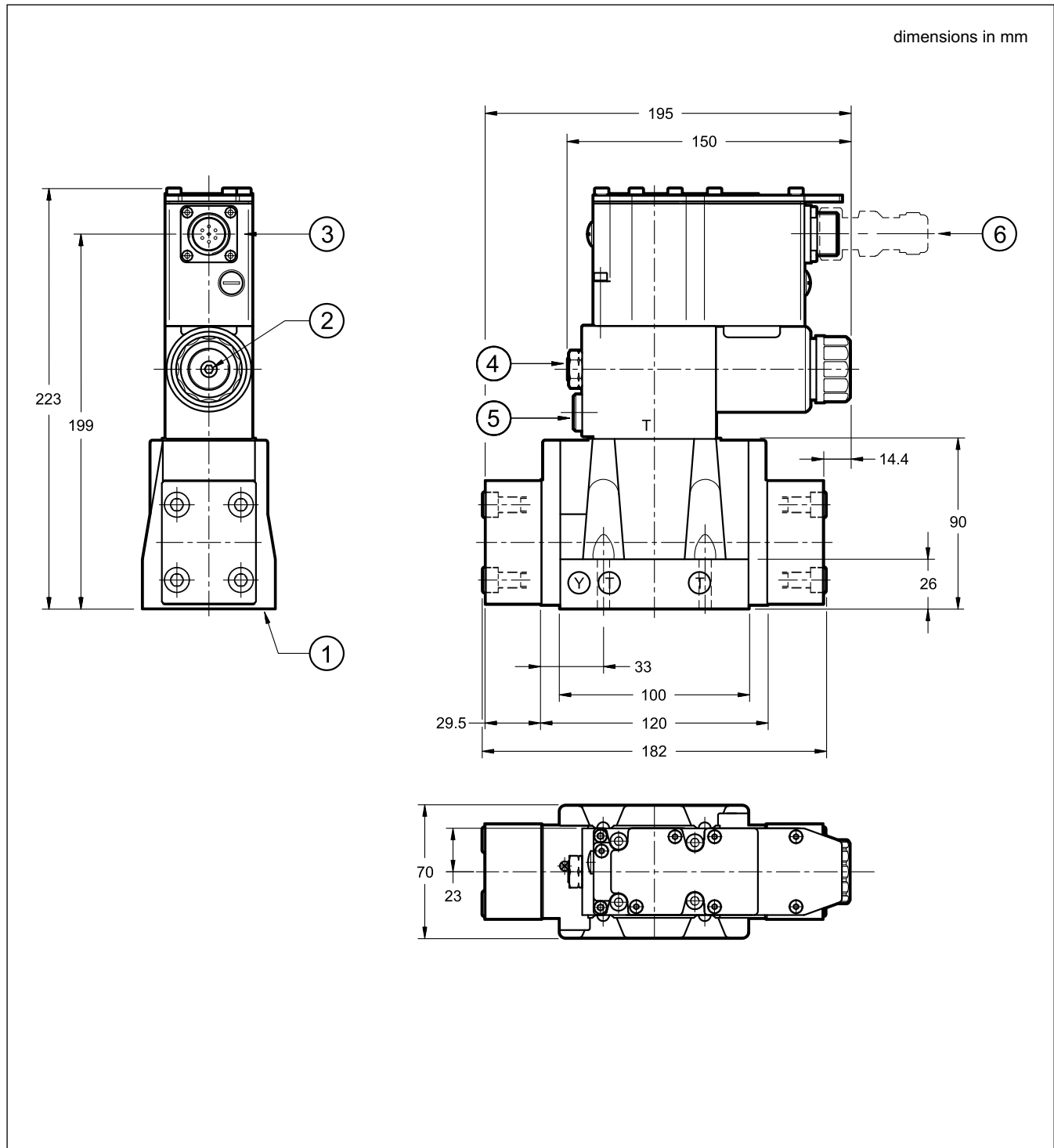

NOTE: at the first start up, or after a long period of no use, it is necessary to vent the air through the breather (2) placed at the end of the solenoid tube.

Mounting surface shown at paragraph 12.

Valve fastening: N. 4 bolts SHC M6x35 - ISO 4762
Tightening torque: 8 Nm (bolts A 8.8)
Thread of mounting holes: M6x10

1	Mounting surface with sealing rings: N. 5 OR type 2050 (12.42x1.78) - 90 Shore N. 2 OR type 2037 (9.25x1.78) - 90 Shore
2	Breather (Allen key 4)
3	Main connection
4	Adjustment seal, set in factory. It is recommended not to unscrew the nut.
5	Pressure gauge port 1/4 BSP"
6	Mating electrical connector to be ordered separately. See at section 15

10 - OVERALL AND MOUNTING DIMENSIONS DZCE7G

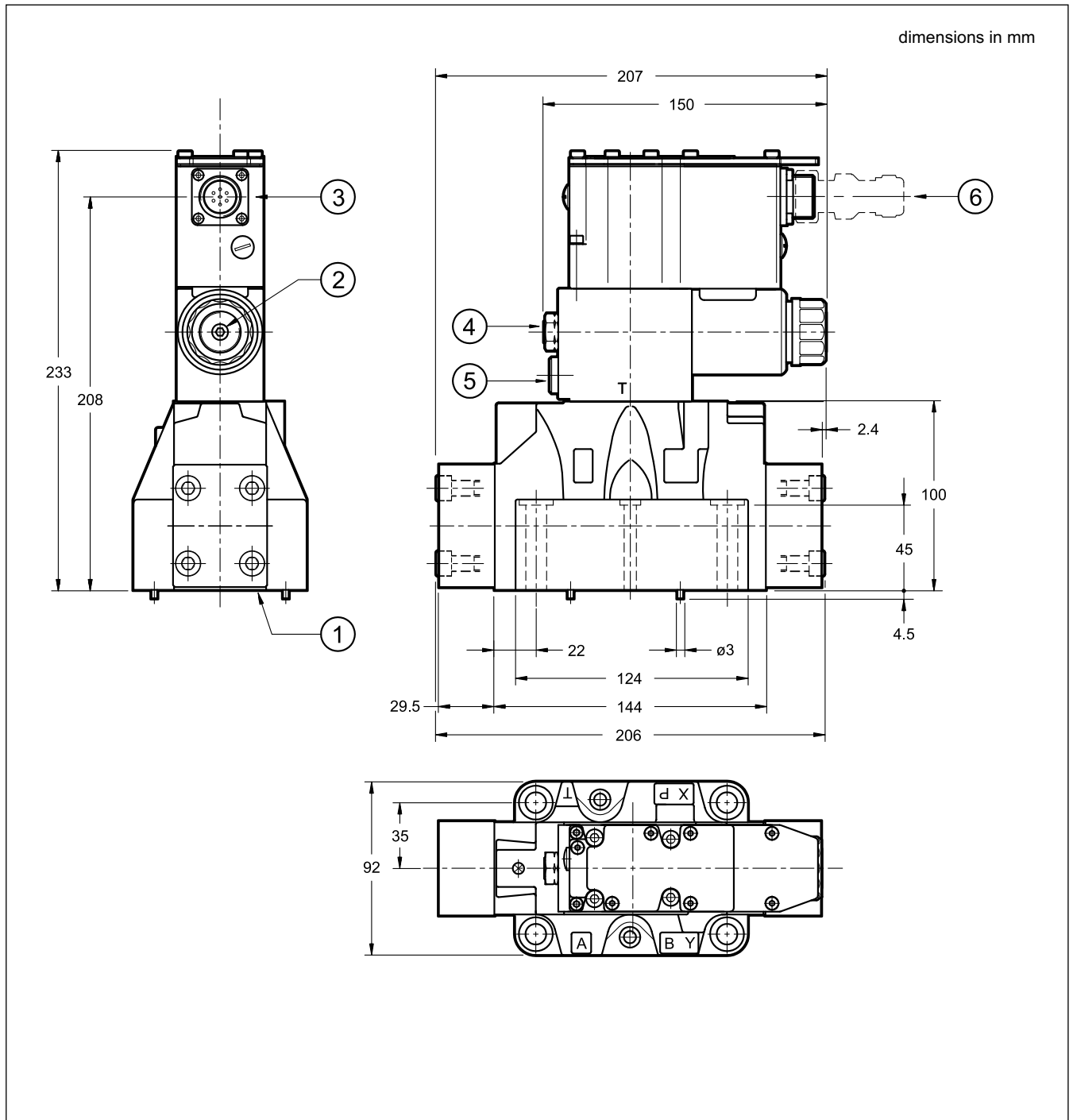

NOTE: at the first start up, or after a long period of no use, it is necessary to vent the air through the breather (2) placed at the end of the solenoid tube.

Mounting surface shown at paragraph 12.

Valve fastening:	N. 4 bolts SHC M10x60 - ISO 4762 N. 2 bolts SHC M6x60 - ISO 4762
Tightening torque:	M10x60: 40 Nm (bolts A 8.8) M6x60: 8 Nm (bolts A 8.8)
Thread of mounting holes:	M6x18; M10x18

1	Mounting surface with sealing rings: N. 4 OR type 130 (22.22x2.62) - 90 Shore N. 2 OR type 2043 (10.82x1.78) - 90 Shore
2	Breather (Allen key 4)
3	Main connection
4	Adjustment seal, set in factory. It is recommended not to unscrew the nut.
5	Pressure gauge port 1/4 BSP"
6	Mating electrical connector to be ordered separately. See at section 15

11 - OVERALL AND MOUNTING DIMENSIONS DZCE8G

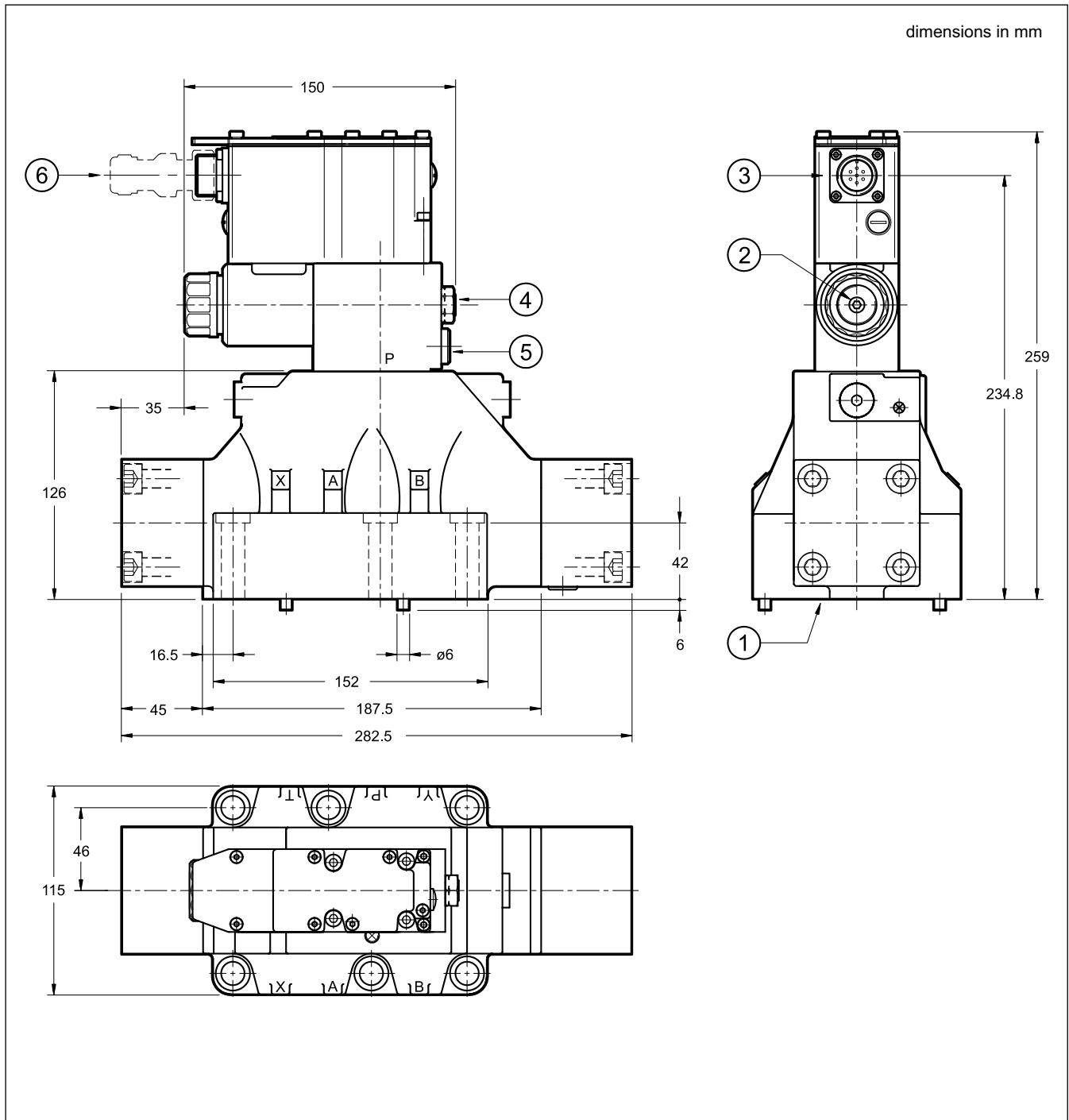

NOTE: at the first start up, or after a long period of no use, it is necessary to vent the air through the breather (2) placed at the end of the solenoid tube.

Mounting surface shown at paragraph 12.

1	Mounting surface with sealing rings: N. 4 OR type 3118 (29.82x2.62) - 90 Shore N: 2 OR type 3081 (20.24x2.62) - 90 Shore
2	Breather (Allen key 4)
3	Main connection
4	Adjustment seal, set in factory. It is recommended not to unscrew the nut.
5	Pressure gauge port 1/4 BSP"
6	Mating electrical connector to be ordered separately. See at section 15

Valve fastening: N. 6 bolts SHC M12x60 - ISO 4762
Tightening torque: 69 Nm (bolts A 8.8)
Thread of mounting holes: M12x20

12 - MOUNTING SURFACES

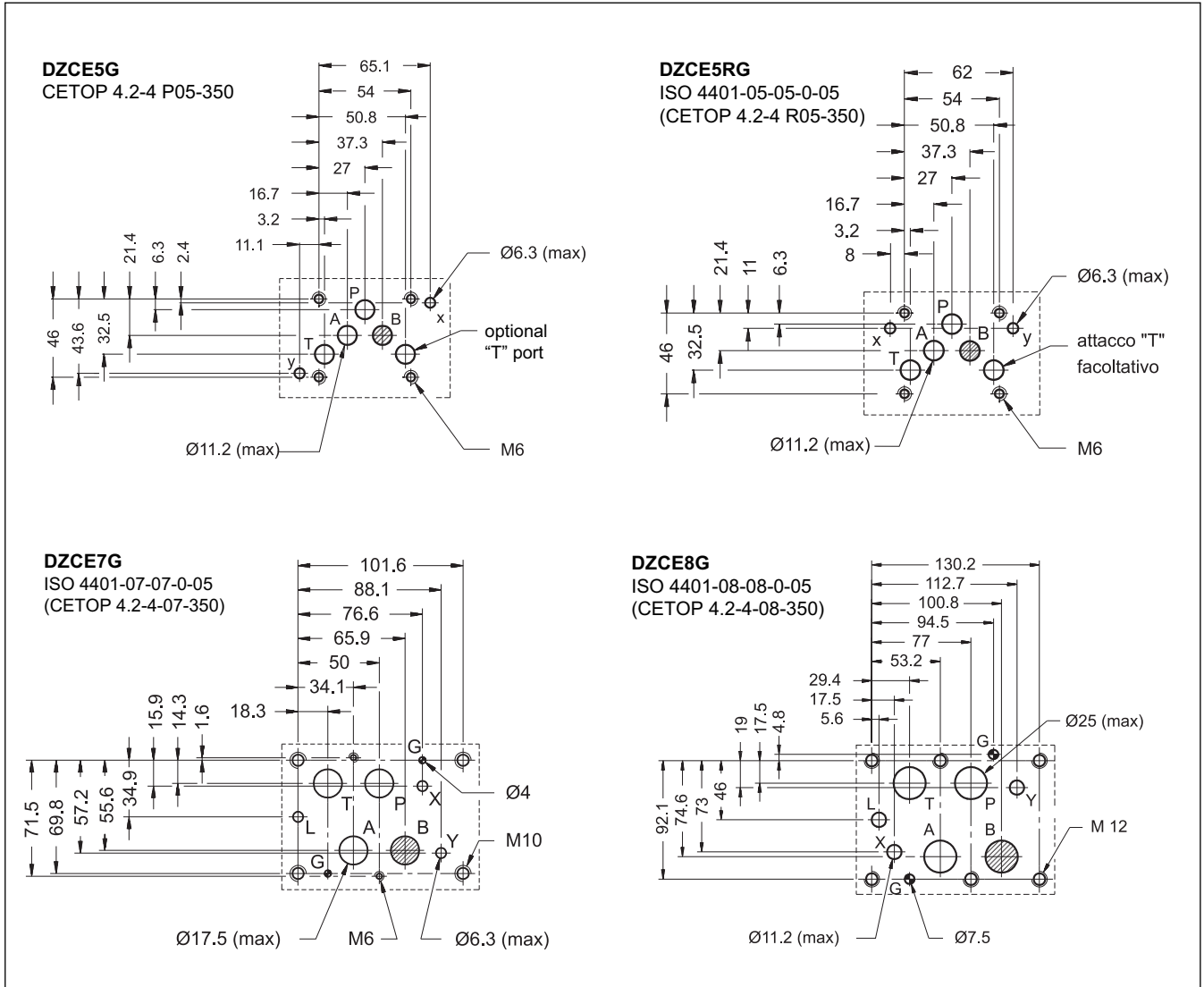

13 - HYDRAULIC FLUIDS

Use mineral oil-based hydraulic fluids HL or HM type, according to ISO 6743-4. For these fluids, use NBR seals. For fluids HFDR type (phosphate esters) use FPM seals (code V). For the use of other kinds of fluid such as HFA, HFB, HFC, please consult our technical department.

Using fluids at temperatures higher than 80 °C causes a faster degradation of the fluid and of the seals characteristics. The fluid must be preserved in its physical and chemical characteristics.

14 - INSTALLATION

We recommend to install the valves either in horizontal position, or vertical position with the solenoid downward. If the valve is installed in vertical position and with the solenoid upward, you must consider possible variations of the minimum controlled pressure, if compared to what is indicated in paragraph 5.

Ensure that there is no air in the hydraulic circuit. In particular applications, can be necessary to vent the air entrapped in the solenoid tube, by using the appropriate drain screw in the solenoid tube.

Ensure the solenoid tube is always filled with oil. At the end of the operation, make sure of having correctly replaced the drain screw.

Connect the valve T port directly to the tank. Add any backpressure value detected in the T line to the controlled pressure value.

Maximum admissible backpressure in the T line, under operational conditions, is 2 bar.

Valves are fixed by means of screws or tie rods on a flat surface with planarity and roughness equal to or better than those indicated in the relative symbols. If minimum values are not observed, fluid can easily leak between the valve and support surface.

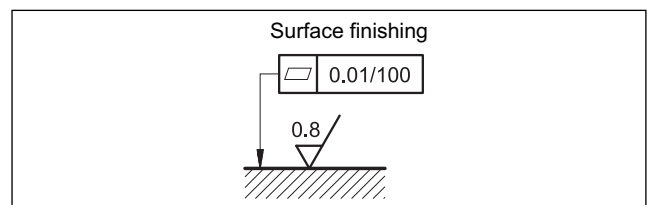



15 - ACCESSORIES

(to be ordered separately)

15.1 Mating connector

These valves have a plug for 7-pin mating connector, that is placed on the box of the integral motion control.



So as to avoid electromagnetic troubles and comply with the electromagnetic compatibility regulation EMC, it is recommended the use of a metal connector.

If a plastic connector is used, make sure that the protection characteristics IP and EMC of the valve are guaranteed.

Duplomatic offers a metal cable connector type MIL-C-5015-G (EN 175201-804).

name: **EX7S/L/10** code **3890000003**

15.2 - Connection cables size

Power supply:

- up to 20 m cable length : 1,0 mm²
- up to 40 m cable length : 1,5 mm²

Signal: 0,50 mm²

A suitable cable would have 7 isolated conductors, a separate screen for the signal wires and an overall screen.

15.3 - Kit for start-up LINPC-USB

Device for service start-up and diagnostic, see catalogue 89850.

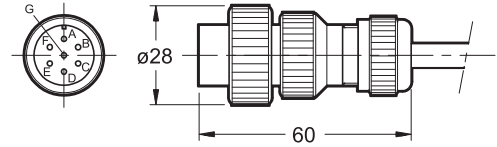

16 - SUBPLATES

(see catalogue 51 000)

	DZCE5G	DZCE7G	DZCE8G
Type with rear ports	PME4-AI5G	PME07-AI6G	-
Type with side ports	PME4-AL5G	PME07-AL6G	PME5-AL8G
Thread of ports:	P - T - A - B X - Y	3/4" BSP 1/4" BSP	1" BSP 1/4" BSP