

Digital electronic E-BM-RES drivers

DIN-rail format, for proportional valves with integral pressure transducer

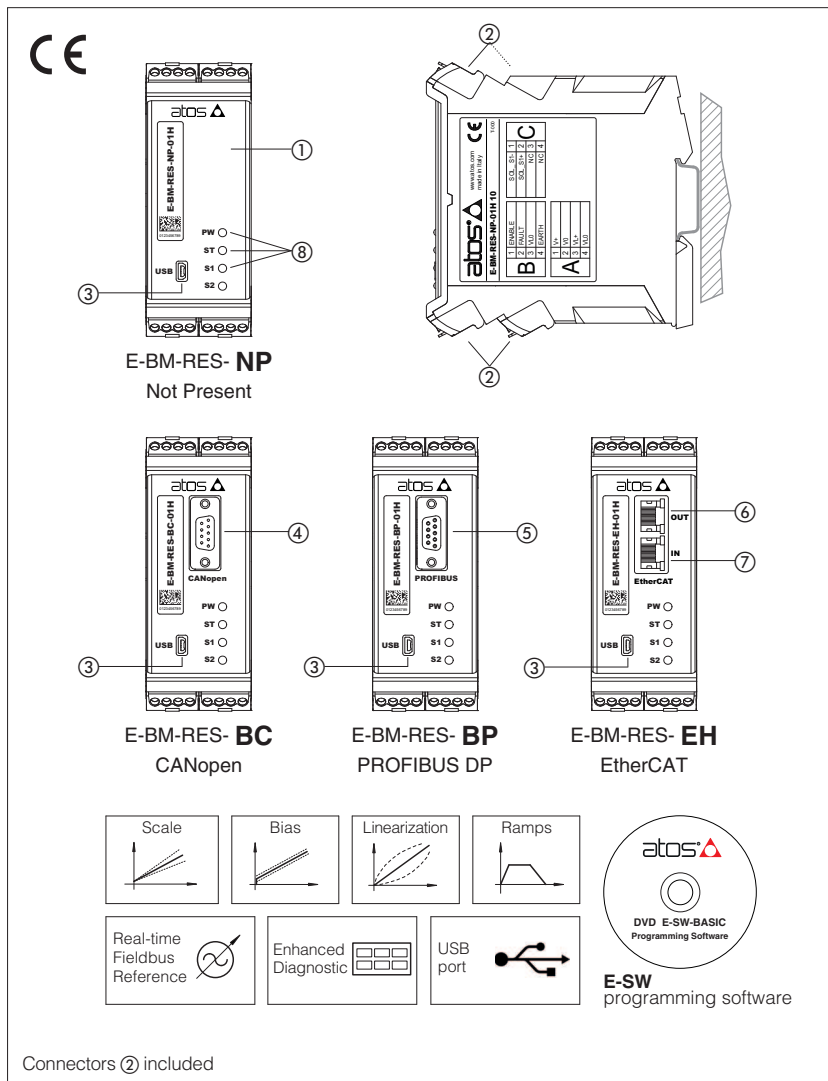

E-BM-RES

Digital drivers ① control, in closed loop, the regulated pressure of direct and pilot operated proportional valves according to the electronic reference input signal.

E-BM-RES operate direct and pilot operated relief/reducing control valves ZO-R with integral pressure transducer.

Atos PC software allows to customize the driver configuration to the specific application requirements.

Electrical Features:

- 7 fast plug-in connectors ②
- Mini USB port ③ always present
- DB9 CANopen ④ and PROFIBUS DP ⑤ communication connector
- RJ45 EtherCAT communication connectors ⑥ output and ⑦ input
- 3 leds for diagnostics ⑧ (see 4.1)
- Pressure transducer input signal $4 \div 20$ mA
- ± 5 Vdc output supply for external reference potentiometer
- Electrical protection against reverse polarity of power supply
- Operating temperature range: $-20 \div +60$ °C
- Plastic box with IP20 protection degree and standard DIN-rail mounting
- CE mark according to EMC directive

Software Features:

- Intuitive graphic interface
- Setting of valve's functional parameters: bias, scale, ramps, dither, PID gains
- 4 factory pre-set dynamic response setting to match different hydraulic conditions (see 8.5)
- Linearization function for hydraulic regulation
- Complete diagnostics of driver status
- Internal oscilloscope function
- In field firmware update through USB port

Fieldbus Features:

- Valve direct communication with machine control unit for digital reference, diagnostics and settings
- Fieldbus execution allow to operate the valves via fieldbus or via analog signals available on the connectors (see 4.2)

1 MODEL CODE

E-BM	-	RES	-	NP	-	01H	/	*	/	*	/	*
Off-board electronic driver in DIN rail format		RES = digital full driver, for valves with pressure transducer		Fieldbus interface - USB port always present: NP = Not Present BC = CANopen BP = PROFIBUS DP EH = EtherCAT		01H = for single solenoid proportional valves		Option: I = current reference input and monitor $4 \div 20$ mA (omit for voltage reference and monitor input $0 \div 10$ Vdc)		Set code (see section 5) Series number		

2 VALVES RANGE

Valves model	Relief			Reducing			Compensator
	RZMO	AGMZO	LIMZO	RZGO	AGRCZO	LIRZO	LICZO
Data sheet	FS010 FS067	FS040	FS305	FS020 FS075	FS055	FS305	FS305
Driver model	E-BM-RES						

3 MAIN CHARACTERISTICS

Power supply (see 6.1, 6.4)	Nominal : +24 Vdc Rectified and filtered : $V_{RMS} = 20 \div 32 V_{MAX}$ (ripple max 10 % V_{PP})			
Max power consumption	50 W			
Current supplied to solenoids	$I_{MAX} = 2.7$ A with +24 Vdc power supply to drive standard proportional valves (3,2 Ω solenoid)			
Analog input signals (see 6.2)	Voltage: maximum range ± 10 Vdc Input impedance: $R_i > 50$ k Ω Current: maximum range ± 20 mA Input impedance: $R_i = 500$ Ω			
Monitor output (see 6.3)	Voltage: maximum range $0 \div 10$ Vdc @ max 5 mA Current: maximum range $0 \div 20$ mA @ max 500 Ω load resistance			
Enable input (see 6.5)	Range : $0 \div 9$ Vdc (OFF state), $15 \div 24$ Vdc (ON state), $9 \div 15$ Vdc (not accepted); Input impedance: $R_i > 87$ k Ω			
Output supply (see 6.8)	± 5 Vdc @ max 10 mA : output supply for external potentiometer			
Fault output (see 6.6)	Output range : $0 \div 24$ Vdc (ON state $\equiv V_L +$ [logic power supply] ; OFF state $\equiv 0$ V) @ max 50 mA; external negative voltage not allowed (e.g. due to inductive loads)			
Pressure transducer power supply	+24Vdc @ max 100 mA (E-ATR-8 see tech table GS465)			
Alarms	Solenoid not connected/short circuit, cable break with current reference signal, over/under temperature, power supplies level, pressure transducer failure, alarms history storage function			
Format	Plastic box ; IP20 protection degree ; L 35 - H 7,5 mm DIN-rail mounting as per EN60715			
Operating temperature	$-20 \div +60$ $^{\circ}C$ (storage $-25 \div +85$ $^{\circ}C$)			
Mass	Approx. 330 g			
Additional characteristics	Short circuit protection of solenoid current supply; current control by P.I.D. with rapid solenoid switching; protection against reverse polarity of power supply			
Compliance	CE according to EMC directive 2014/30/EU (Immunity: EN 61000-6-2; Emission: EN 61000-6-3) RoHS Directive 2011/65/EU as last update by 2015/65/EU REACH Regulation (EC) n°1907/2006			
Communication interface	USB Atos ASCII coding	CANopen EN50325-4 + DS408	PROFIBUS DP EN50170-2/IEC61158	EtherCAT IEC61158
Communication physical layer	not insulated USB 2.0 + USB OTG	optical insulated CAN ISO11898	optical insulated RS485	Fast Ethernet 100 Base TX
Recommended wiring cable	LiYCY shielded cables: 0,5 mm ² max 50 m for logic - 1,5 mm ² max 50 m for power supply and solenoids			
Max conductor size (see 10)	2,5 mm ²			

Note: a maximum time of 500 ms (depending on communication type) have be considered between the driver energizing with the 24 Vdc power supply and when the valve is ready to operate. During this time the current to the valve coils is switched to zero.

4 CONNECTIONS AND LEDS

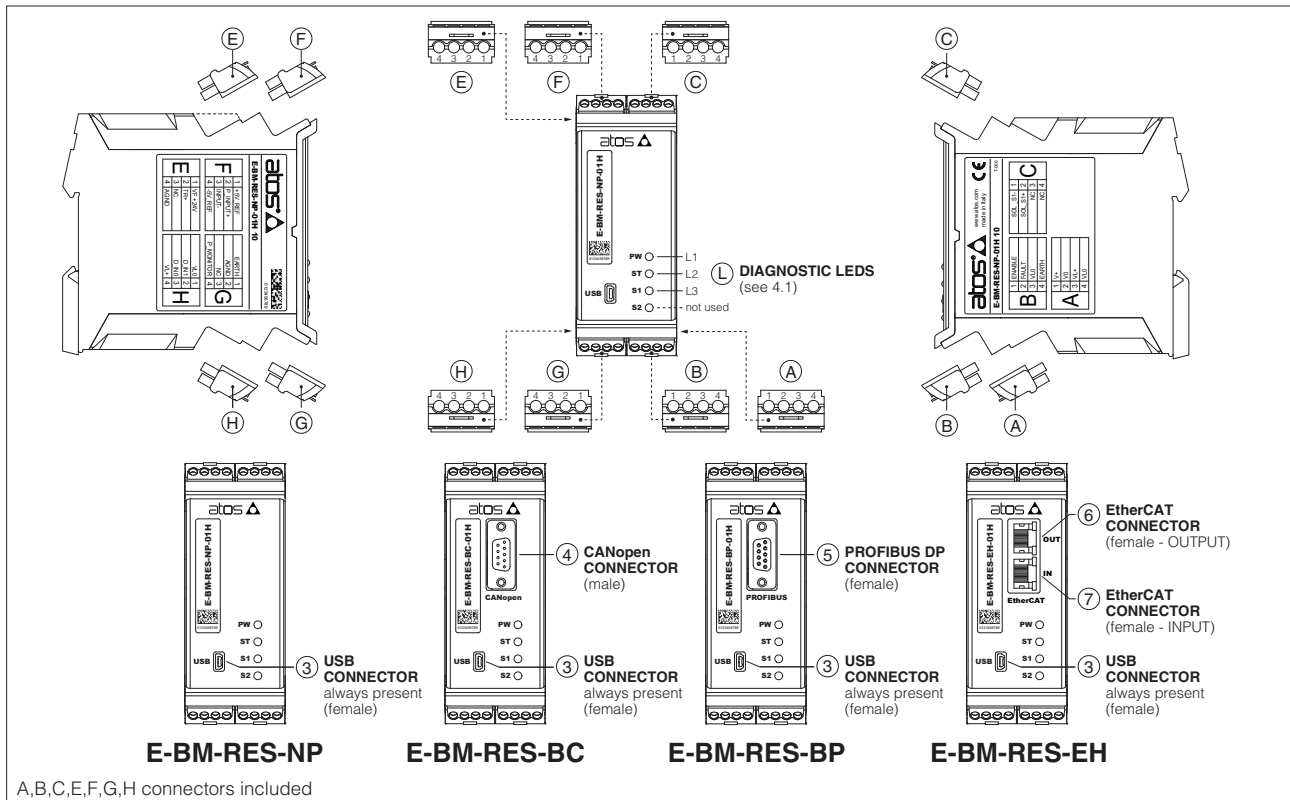

4.1 Diagnostic LEDs (L)

Three leds show driver operative conditions for immediate basic diagnostics. Please refer to the driver user manual for detailed information.

LED	COLOR	FUNCTION	FLASH RATE	DESCRIPTION
L1	GREEN	PW	OFF	Power supply OFF
			ON	Power supply ON
L2	GREEN	ST	OFF	Fault present
			ON	No fault
L3	YELLOW	S1	OFF	PWM command OFF
			ON	PWM command ON

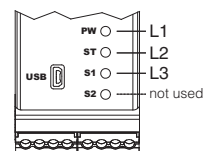

4.2 Connectors - 4 pin

CONNECTOR	PIN	SIGNAL	TECHNICAL SPECIFICATIONS	NOTES
A	A1	V+	Power supply 24 Vdc (see 6.1)	Input - power supply
	A2	V0	Power supply 0 Vdc (see 6.1)	Gnd - power supply
	A3	VL+	Power supply 24 Vdc for driver's logic and communication (see 6.4)	Input - power supply
	A4	VLO	Power supply 0 Vdc for driver's logic and communication (see 6.4)	Gnd - power supply
B	B1	ENABLE	Enable (24 Vdc) or disable (0 Vdc) the driver, referred to VLO (see 6.5)	Input - on/off signal
	B2	FAULT	Fault (0 Vdc) or normal working (24 Vdc), referred to VLO (see 6.6)	Output - on/off signal
	B3	VLO	Ground for ENABLE and FAULT	Gnd - digital signals
	B4	EARTH	Connect to system ground	
C	C1	SOL_S1-	Negative current to solenoid S1	Output - power PWM
	C2	SOL_S1+	Positive current to solenoid S1	Output - power PWM
	C3	NC	Do not connect	
	C4	NC	Do not connect	
E	E1	VF +24V	Power supply +24 Vdc	Output - power supply
	E2	TR+	Positive pressure transducer input signal: ± 20 mA maximum range (see 6.7) Default is 4 \div 20 mA	Input - analog signal Software selectable
	E3	NC	Do not connect	
	E4	AGND	Common GND for transducer power, signals and external potentiometer	
F	F1	+5V_REF	External potentiometer power supply +5 Vdc @ 10mA (see 6.8)	Output - power supply
	F2	P_INPUT+	Positive pressure reference input signal: ± 10 Vdc / ± 20 mA maximum range (see 6.2) Defaults are 0 \div 10 Vdc for standard and 4 \div 20 mA for /I option	Input - analog signal Software selectable
	F3	INPUT-	Negative pressure reference input signal for P_INPUT+	Input - analog signal
	F4	-5V_REF	External potentiometer power supply -5 Vdc @ 10mA (see 6.8)	Output - power supply
G	G1	EARTH	Connect to system ground	
	G2	AGND	Analog ground for P_MONITOR and external potentiometer	Gnd - analog signal
	G3	NC	Do not connect	
	G4	P_MONITOR	Pressure monitor output signal: 0 \div 10 Vdc / 0 \div 20 mA maximum range (see 6.3) Default are 0 \div 10 Vdc for standard and 4 \div 20 mA for /I option	Output - analog signal Software selectable
H	H1	VLO	Power supply 0 Vdc for digital input (see 6.4)	Gnd - power supply
	H2	D_IN1	Pressure PID selection, referred to VLO (see 6.9)	Input - on/off signal
	H3	D_IN0	Pressure PID selection, referred to VLO (see 6.9)	Input - on/off signal
	H4	VL+	Power supply 24 Vdc for digital input (see 6.4)	Output - power supply

Pressure transducer connection

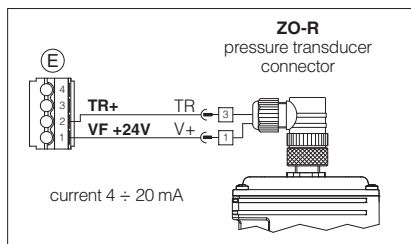

Coil connection

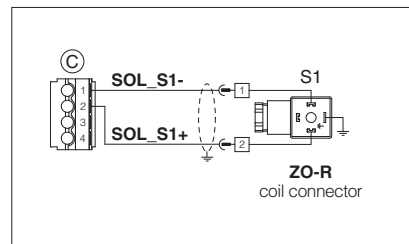

Potentiometer connection

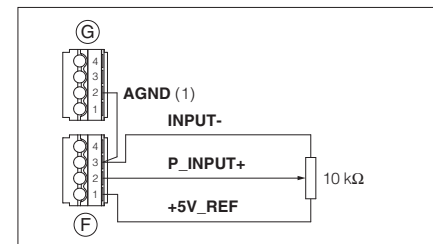

(1) As alternative the AGND on pin E4 can be used

4.3 Communication connectors ③ - ④ - ⑤ - ⑥ - ⑦

③ USB connector - Mini USB type B always present		
PIN	SIGNAL	TECHNICAL SPECIFICATION (1)
1	+5V_USB	Power supply
2	D-	Data line -
3	D+	Data line +
4	ID	Identification
5	GND_USB	Signal zero data line

⑤ BP fieldbus execution, connector - DB9 - 9 pin		
PIN	SIGNAL	TECHNICAL SPECIFICATION (1)
1	SHIELD	
3	LINE-B	Bus line (low)
5	DGND	Data line and termination signal zero
6	+5V	Termination supply signal
8	LINE-A	Bus line (high)

④ BC fieldbus execution, connector - DB9 - 9 pin		
PIN	SIGNAL	TECHNICAL SPECIFICATION (1)
2	CAN_L	Bus line (low)
3	CAN_GND	Signal zero data line
5	CAN_SHLD	Shield
7	CAN_H	Bus line (high)

⑥ ⑦ EH fieldbus execution, connector - RJ45 - 8 pin		
PIN	SIGNAL	TECHNICAL SPECIFICATION (1)
1	TX+	Transmitter - white/orange
2	RX+	Receiver - white/green
3	TX-	Transmitter - orange
6	RX-	Receiver - green

(1) shield connection on connector's housing is recommended

5 SET CODE

The basic calibration of electronic driver is factory preset, according to the proportional valve **ZO-R** to be coupled. These pre-calibrations are identified by the set code at the end of driver's model code (see section 1). For correct set code selection, please include in the driver order also the complete code of the coupled proportional valve **ZO-R**. For further information about set code, please contact Atos technical office.

6 POWER SUPPLY AND SIGNALS SPECIFICATIONS

Atos digital drivers are CE marked according to the applicable directives (e.g. Immunity and Emission EMC Directive). Installation, wirings and start-up procedures must be performed according to the general prescriptions shown in tech table **FS900** and in the user manuals included in the E-SW-* programming software. Generic electrical output signals of the valve (e.g. fault or monitor signals) must not be directly used to activate safety functions, like to switch-ON/OFF the machine's safety components, as prescribed by the European standards (Safety requirements of fluid technology systems and components-hydraulics, EN-982).

6.1 Power supply (V+ and V0)

The power supply must be appropriately stabilized or rectified and filtered: apply at least a 10000 μ F/40 V capacitance to single phase rectifiers or a 4700 μ F/40 V capacitance to three phase rectifiers. In case of double power supply see 6.4. A safety fuse is required in series to each power supply: 2,5 A time lag fuse.

6.2 Pressure reference input signal (P_INPUT+)

The driver controls in closed loop the current to the valve pressure proportionally to the external reference input signal. Reference input signal is factory preset according to selected valve code, defaults are 0 \div 10 V_{bc} for standard and 4 \div 20 mA for /I option. Input signal can be reconfigured via software selecting between voltage and current, within a maximum range of \pm 10 V_{bc} or \pm 20 mA. Drivers with fieldbus interface (BC, BP, EH) can be software set to receive reference signal directly by the machine control unit (fieldbus reference). Analog reference input signal can be used as on-off commands with input range 0 \div 24V_{bc}.

6.3 Pressure monitor output signal (P_MONITOR)

The driver generates an analog output signal proportional to the actual pressure of the valve; the monitor output signal can be software set to show other signals available in the driver (e.g. analog reference, fieldbus reference). Monitor output signal is factory preset according to selected valve code, defaults settings are 0 \div 10 V_{bc} for standard and 4 \div 20 mA for /I option. Output signal can be reconfigured via software selecting between voltage and current, within a maximum range of 0 \div 10 V_{bc} or 0 \div 20 mA.

6.4 Power supply for driver's logic and communication (VL+ and VL0)

The power supply for driver's logic and communication must be appropriately stabilized or rectified and filtered: apply at least a 10000 μ F/40 V capacitance to single phase rectifiers or a 4700 μ F/40 V capacitance to three phase rectifiers. The separate power supply for driver's logic on pin A3 and A4, allow to remove solenoid power supply from pin A1 and A2 maintaining active the diagnostics, USB and fieldbus communications. A safety fuse is required in series to each driver's logic and communication power supply: 500 mA fast fuse.

6.5 Enable input signal (ENABLE)

To enable the driver, supply 24 V_{bc} on pin B1: Enable input signal allows to enable/disable the current supply to the solenoid, without removing the electrical power supply to the driver; it is used to active the communication and the other driver functions when the valve must be disabled for safety reasons. This condition does not comply with European Norms EN13849-1 (ex EN954-1).

6.6 Fault output signal (FAULT)

Fault output signal indicates fault conditions of the driver (solenoid short circuits/not connected, reference signal broken for 4 \div 20 mA input, etc.). Fault presence corresponds to 0 VDC, normal working corresponds to 24 V_{bc}. Fault status is not affected by the Enable input signal.

6.7 Pressure transducer integrated to the valve, input signal (TR+)

Analog pressure transducer integrated to the valve, has to be directly connected to the driver. Analog input signal is factory preset according to selected driver code, default is 4 \div 20 mA. Input signal can be reconfigured via software, within a maximum range of \pm 20 mA.

6.8 Output supply for external potentiometer (\pm 5V_REF) - not available for EH version

The reference analog signal can be generated by one external potentiometer directly connected to the driver, using the \pm 5 V_{bc} supply output available at pin F1 and F4.

Note: using an external potentiometer, the reference input signal must be set via software at 0 \div 5 V_{bc} (default 0 \div 10 V_{bc}, see 6.2)

6.9 PID selection (D_IN0 and D_IN1)

Two on-off input signals are available on the pin H2 and H3 to select one of the four pressure PID parameters setting, stored into the driver. Supply a 24 V_{bc} or a 0 V_{bc} on pin H2 and/or pin H3, to select one of the PID settings as indicated by binary code table at side. Gray code can be selected by software. Refer to dynamic response for function description (see 8.5).

PID SET SELECTION				
PIN	SET 1	SET 2	SET 3	SET 4
H2	0	24 V _{bc}	0	24 V _{bc}
H3	0	0	24 V _{bc}	24 V _{bc}

7 PROGRAMMING TOOLS - see tech table GS500

Valve's functional parameters and configurations, can be easily set and optimized using Atos E-SW programming software connected via USB port to the digital driver (see table **FS900**). For fieldbus versions, the software permits valve's parameterization through USB port also if the driver is connected to the central machine unit via fieldbus.

The software is available in different versions according to the driver's options (see table **GS500**):

E-SW-BASIC support: NP (USB) PS (Serial) IR (Infrared)
E-SW-FIELDBUS support: BC (CANopen) BP (PROFIBUS DP) EH (EtherCAT)
EW (POWERLINK) EI (EtherNet/IP) EP (PROFINET)
E-SW-*/PQ support: valves with SP, SF, SL alternated control (e.g. E-SW-BASIC/PQ)

WARNING: drivers USB port is not isolated! For E-C-SB-USB/BM cable, the use of isolator adapter is highly recommended for PC protection

Free programming software, web download:

E-SW-BASIC web download = software can be downloaded upon web registration at www.atos.com; service and DVD not included
Upon web registration user receive via email the Activation Code (software free license) and login data to access Atos Download Area

DVD programming software, to be ordered separately:

E-SW-*/PQ DVD first supply = software has to be activated via web registration at www.atos.com; 1 year service included
Upon web registration user receive via email the Activation Code (software license) and login data to access Atos Download Area

E-SW-*/N/PQ DVD next supplies = only for supplies after the first; service not included, web registration not allowed
Software has to be activated with Activation Code received upon first supply web registration

Atos Download Area: direct access to latest releases of E-SW software, manuals, USB drivers and fieldbus configuration files at www.atos.com

USB Adapters, Cables and Terminators, can be ordered separately

USB connection

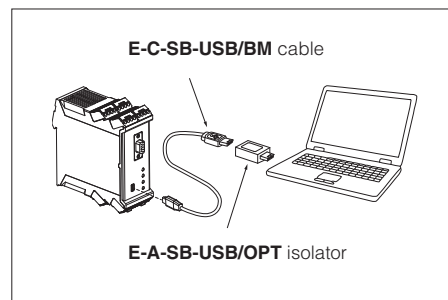

8 MAIN SOFTWARE PARAMETER SETTINGS

The following is a brief description of the main settings and features of digital drivers.

For a detailed descriptions of available settings, wirings and installation procedures, please refer to the user manual included in the E-SW programming software:

E-MAN-BM-RES - user manual for **E-BM-RES**

8.1 Scale

Scale function allows to set the maximum current supplied to the solenoid, corresponding to the max pressure valve regulation, at maximum reference signal value.

This regulation allows to adapt the maximum current supplied from the driver to the specific nominal current of the pressure proportional valves to which the driver is coupled; it is also useful to reduce the maximum valve regulation in front of maximum reference signal.

8.1, 8.2 - Scale, Bias & Threshold

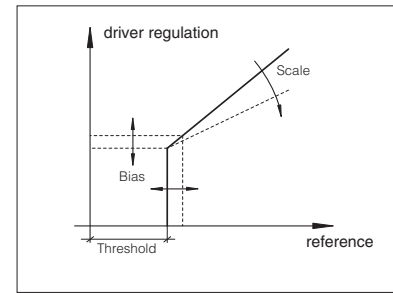

8.2 Bias and Threshold

Pressure proportional valves may be provided with a dead band in the hydraulic regulation corresponding to their switch-off status.

This dead band discontinuity in the pressure valve's regulation can be compensated by activating the Bias function, which adds a fixed preset Bias value to the reference signal (analog or fieldbus external input).

The Bias function is activated when the reference signal overcomes the Threshold value, preset into the driver.

The Bias setting allows to calibrate the Bias current to the specific pressure proportional valve to which the driver is coupled.

The Threshold setting is useful to avoid undesired valve regulation at zero reference signal when electric noise is present on the analog input signal: smaller threshold reduces the reference signal dead band, greater values are less affected by electric noise presence.

If fieldbus reference signal is active (see 6.2), threshold should be set to zero.

Refer to the programming manuals for a detailed description of other software selectable Bias functions.

8.3 - Ramps

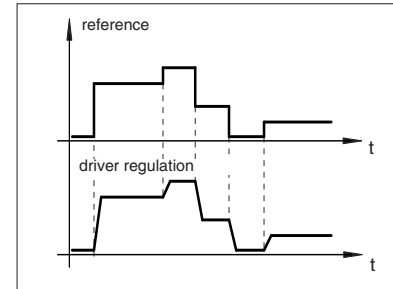

8.3 Ramps

The ramp generator allows to convert sudden change of electronic reference signal into smooth time-dependent increasing/decreasing of the current supplied to the solenoid.

Different ramp mode can be set:

- single ramp for any reference variation
- two ramps for increasing and for decreasing reference variations

Ramp generator is useful for application where smooth hydraulic actuation is necessary to avoid machine vibration and shocks.

If the pressure proportional valve is driven by a closed loop controller, the ramps can lead to unstable behaviour, for these applications ramp function can be software disabled (default setting).

8.4 - Linearization

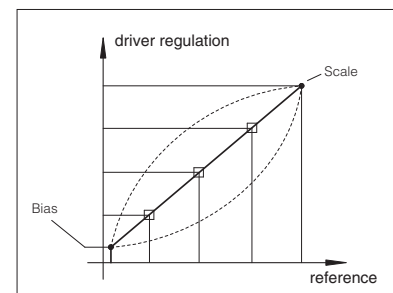

8.4 Linearization - E-SW level 2 functionality

Linearization function allows to set the relation between the reference input signal and the controlled valve's pressure regulation. Linearization is useful for applications where it is required to linearize the valve's pressure regulation in a defined working condition.

8.5 Dynamic response – 4 pressure PIDs

The valve is provided with 4 PIDs configurations to match different hydraulic conditions. The required PID configuration can be selected in real time through digital inputs (see 6.9). Only for BC, BP, EH execution, the PID can be also selected in real time through PLC via fieldbus.

PID	Dynamic response example diagrams at side
1	Fast (default) interchangeable with TERS version
2	Standard
3	Smooth
4	Open Loop

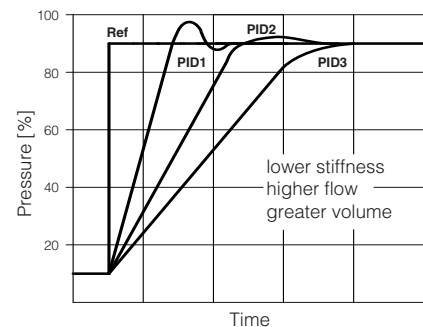
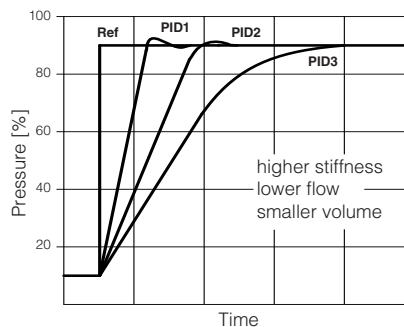

Above indications have to be considered as a general guideline, being affected by hydraulic circuit stiffness, working flow and dead volume. The valve's dynamics can be further optimized on the specific application, customizing PIDs parameters.

In case of pressure instability, select PID4 to operate the valve in open loop.

If the instability still persists, check eventual anomalies in the hydraulic circuit as the presence of air.

If the instability disappears, select an alternative configuration within PID selection 1, 2 or 3 which better matches the application requirements.

If no one of the above selection fulfills the application, tune P - I - D parameters at E-SW software level 2 to obtain the desired dynamic response.

8.6 Pressure transducer failure

This function is available only for pressure transducer input configured in current as $4 \div 20$ mA.

In case of pressure transducer failure, the valve's reaction can be configured through Atos E-SW software to:

- cut off the current to solenoid, therefore the regulated pressure will be reduced to minimum value (default setting)
- automatically switch the pressure control from closed loop (PID1,2,3) to open loop (PID4), to let the valve to temporarily operate with reduced regulation accuracy

9 OVERALL DIMENSIONS [mm]

overall dimension with assembled connectors

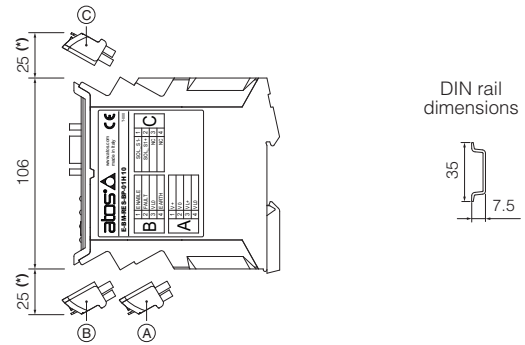
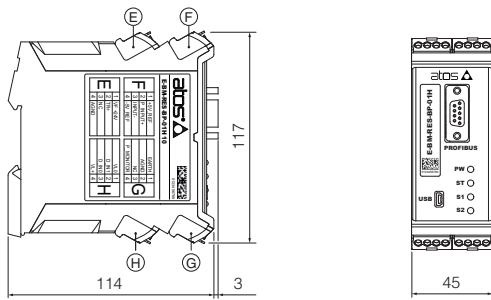

DIN rail dimensions



A, B, C, E, F, G, H connectors included

(*) Space to remove the connectors

10 INSTALLATION

To wire cables in the connectors:

1. insert cable into the termination
2. turn screw with a screwdriver

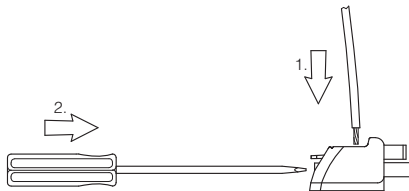

Note: max conductor size: 2,5 mm²
tightening torque: 0,4 ÷ 0,6 Nm

To unlock the driver from the DIN rail:

1. pull down the locking slide with a screwdriver
2. rotate up the driver

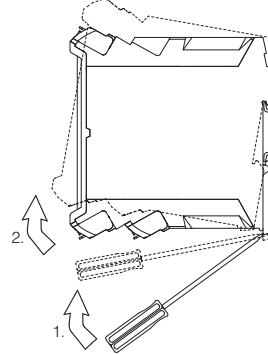

To extract the connectors:

1. push lever
2. pull connector

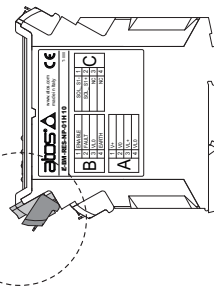
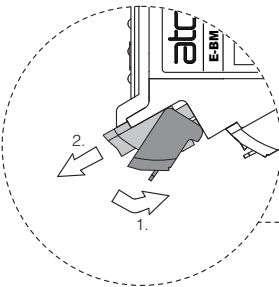

To insert the connectors:

1. push the connector in its slot

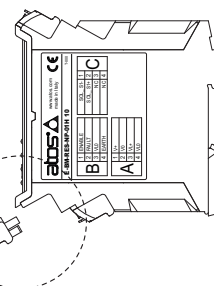
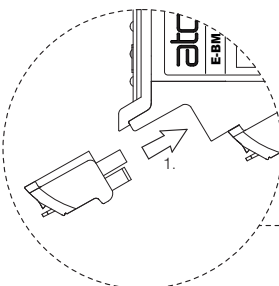

Note: all connectors are supplied with a mechanical coding. This feature ensures a unique insertion of each connector in the own slot (eg. connector A can not be inserted into connector slot of B, C, E, F, G, H)