

Digital electronic E-MI-AS-IR drivers

DIN 43650 plug-in format, for proportional valves without transducer

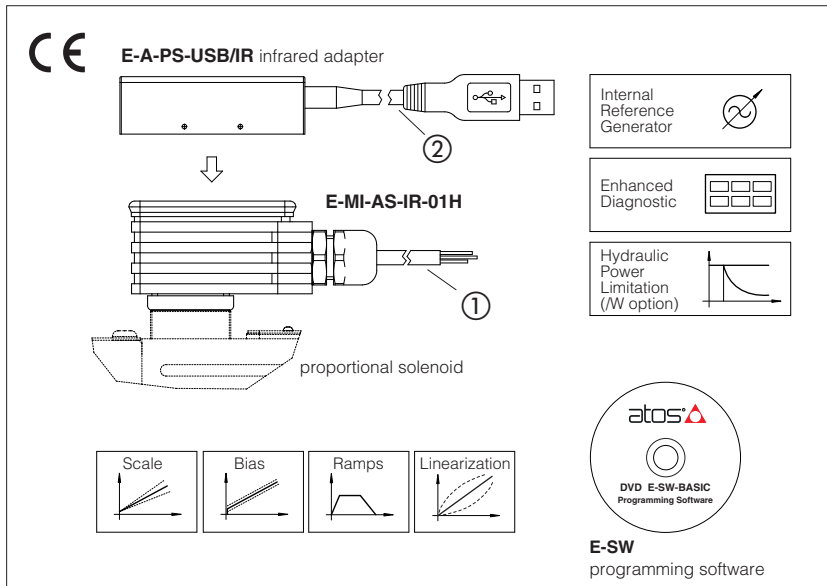

1 MODEL CODE

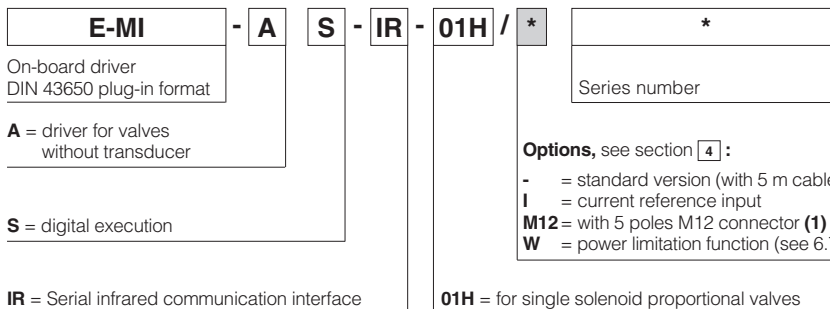

(1) ZH-5P female connector must be ordered separately

2 BLOCK DIAGRAM

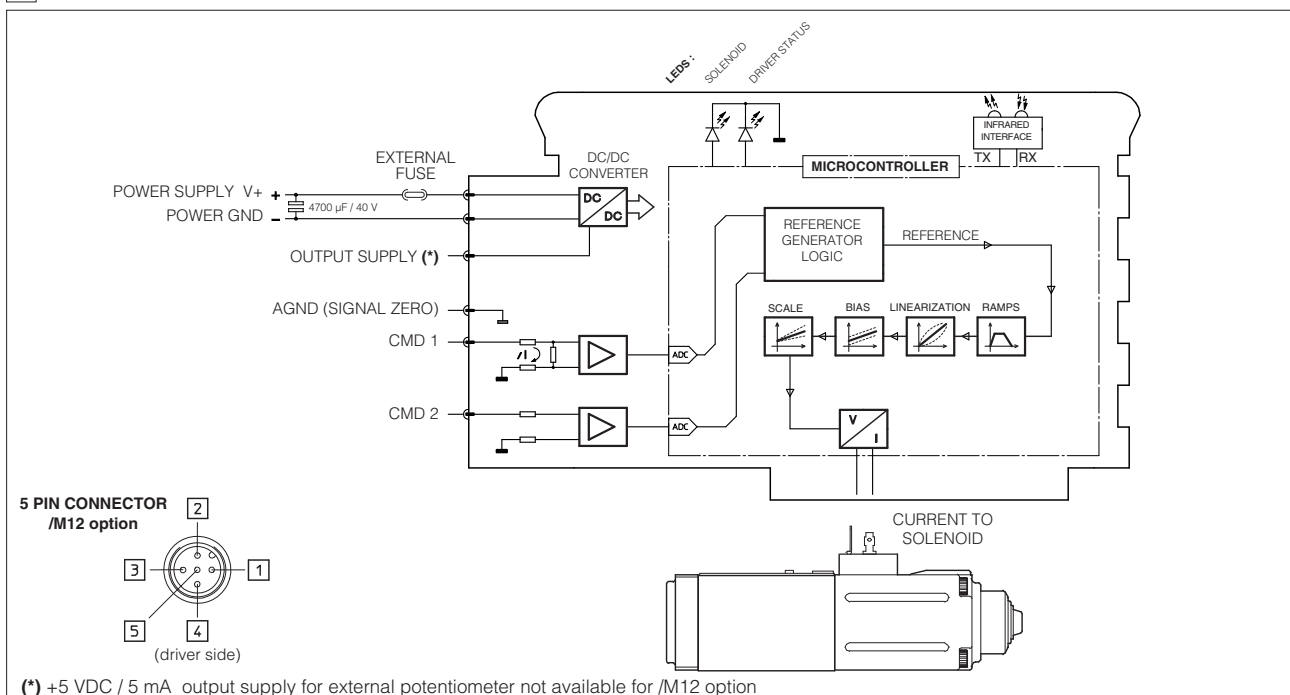

E-MI-AS-IR

Digital drivers are designed for mounting on the solenoid's DIN connector of proportional valves without transducer. They supply and control the current to the solenoid according to the electronic reference input signal. The solenoid proportionally transforms the current into a force, acting on the valve spool or poppet, against a reacting spring, thus providing the valve's hydraulic regulation.

E-MI-AS drivers can drive single or double solenoid proportional valve.

Electrical Features:

- Standard 5m cable connection ① or M12 connector (/M12 option)
- Infrared communication interface ② to program the driver with Atos PC software
- 2 leds for diagnostics (see 9)
- +5 Vdc output supply for external reference potentiometer (not available for /M12 option)
- Operating temperature range: -20° ÷ +50°
- Current reference input (/I option)
- Plastic box with IP65 protection degree and standard DIN43650 plug-in format with double earth connection to allow double-side orientation
- CE mark according to EMC directive

Software Features:

- Intuitive graphic interface
- Setting of valve's functional parameters: bias, scale, ramps, dither
- Linearization function for the hydraulic regulation
- 2 selectable modes for electronic reference signal: external analog input or internal generation
- /W option max power limitation function (see 6.7)
- Complete diagnostics of driver status

3 MAIN CHARACTERISTICS

Power supply (see 4.1)	Nominal: +24 V _{DC} Nominal: +12 V _{DC}	Rectified and filtered: $V_{RMS} = 20 \div 27 V_{MAX}$ (ripple max 10 % V_{PP}) Rectified and filtered: $V_{RMS} = 10 \div 14 V_{MAX}$ (ripple max 10 % V_{PP})
Max power consumption	50 W	
Current supplied to solenoids	$I_{MAX} = 2.7 A$ with +24 V _{DC} power supply to drive standard proportional valves (3,2 Ω solenoid) $I_{MAX} = 3.3 A$ with +12 V _{DC} power supply to drive proportional valves with /6 option (2,1 Ω solenoid)	
Reference input signal (1) (CMD1 - see 4.2)	Standard (voltage) Input range: 0 \div 10 V _{DC} /I option (current) Input range: 4 \div 20 mA / 0 \div 20 mA	Input impedance: $R_i > 50 k\Omega$ Input impedance: $R_i = 500 \Omega$
Enable Input Signal (CMD2 - see 4.5) ON/OFF Input Signal (CMD1,CMD2 - see 4.6)	Input range: 0 \div 24 V _{DC} (OFF state: 0 \div 5 V _{DC} ; ON state: 9 \div 24 V _{DC}) Input impedance: $R_i > 10 k\Omega$	
Pressure transducer input (CMD2 - see 4.3)	/W option	Input range: 0 \div 10 V _{DC} Input impedance: $R_i > 50 k\Omega$
Output supply (see 4.4)	+5 V @ max 5 mA: output supply for external potentiometer (not available for /M12 option)	
Alarms	Solenoid coil not connected, short circuit and cable break with current reference signal (/I option)	
Format	Plastic box ; IP65 protection degree (when fixed on solenoid); DIN43650 format	
Operating temperature	-20 \div +50 °C (storage -25 \div +85 °C)	
Mass	Standard version: 450 g; /M12 option: 70 g	
Additional characteristics	Short circuit protection of current output to solenoid	
Compliance	CE according to EMC directive 2014/30/EU (Immunity: EN 61000-6-2; Emission: EN 61000-6-4) RoHS Directive 2011/65/EU as last update by 2015/65/EU REACH Regulation (EC) n°1907/2006	
Communication interface	Infrared, Atos protocol with ASCII coding; E-A-PS-USB/IR adapter is required (see section 5)	
Wiring cable characteristics	2 poles x 0,5 mm ² plus 4 poles x 0,35 mm ² , external diameter 7,4 mm	

(1) Negative reference input signal not allowed

4 POWER SUPPLY AND SIGNALS SPECIFICATIONS

4.1 Power supply

The power supply must be appropriately stabilized or rectified and filtered: apply at least a 10000 $\mu F/40 V$ capacitance to single phase rectifiers or a 4700 $\mu F/40 V$ capacitance to three phase rectifiers.

According to power supply value, a safety fuse is required in series to each driver:

+24 V_{DC} - 2,5 A time lag fuse

+12 V_{DC} - 4 A time lag fuse

4.2 Reference Input Signal (CMD1: yellow/pin 4, referred to AGND: white/pin 3)

The driver proportionally transforms the external reference signal input into the current supplied to the solenoid.

The driver is designed to receive one analog reference input (CMD1 on yellow/pin 4) referred to the analog electric ground (AGND on white/pin3) and with a maximum range of 0 \div 10 V_{DC}. Internal reference generation is software selectable (see 6.6).

Option /I (current reference input)

The reference input signal maximum range is software selectable among current 4 \div 20 mA (with cable break detection) or 0 \div 20 mA.

4.3 Pressure Input Signal (CMD2: blue/pin 5) - only for /W option

When hydraulic power limitation is active (see 6.7), enable input (CMD2) is managed as an analog input and has to be connected to an external pressure transducer installed on the hydraulic system; maximum input range 0 \div 10 V_{DC}.

4.4 Output supply for external potentiometer - (OUTPUT SUPPLY: green, referred to AGND: white) - not available for /M12 option

The reference analog signal can be generated by an external potentiometer directly connected to the driver, using the +5V_{DC} supply output available at green wire thus generating the desired reference signal.

4.5 Enable Input Signal (CMD2: blue/pin 5, referred to AGND: white/pin 3)

Enable input signal allows to enable/disable the current supply to the solenoid, without removing the electrical power supply to the driver; it is used to maintain active the infrared connection and the other driver functions when the valve must be disabled for safety reasons.

To enable the driver, supply a 24V_{DC} on CMD2 (blue/pin 5, referred to white/pin 3).

The polarity of the enable input can be customized and the enable function can be deactivated, see table at side.

4.6 ON/OFF Input Signals (CMD1: yellow/pin 4, CMD2: blue/pin 5)

When the driver is configured in internal reference generation mode (see 6.6), both reference input (CMD1) and enable input (CMD2) are managed as ON/OFF input signals. In this mode they are used to select the active reference signal, among the available stored values.

4.7 Possible combined options: /IM12, /IM12W, /IW and /M12W

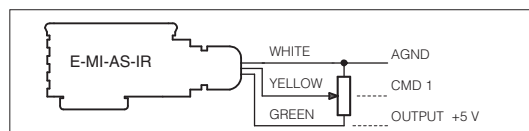

ENABLE CONFIGURATION

Signal	default polarity	reverse polarity	deactivated
9 \div 24 V _{DC}	solenoid ON	solenoid OFF	solenoid ON
0 \div 5 V	solenoid OFF	solenoid ON	solenoid ON

5 VALVE SETTINGS AND PROGRAMMING TOOLS

Valve's functional parameters and configurations, can be easily set and optimized using Atos E-SW programming software connected via RS232 serial port to the digital driver (see table FS900).

For fieldbus versions, the software permits valve's parameterization through USB port also if the driver is connected to the central machine unit via fieldbus.

The software is available in different versions according to the driver's options (see table GS500):

E-SW-BASIC support: NP (USB) PS (Serial) IR (Infrared)

E-SW-FIELDBUS support: BC (CANopen) BP (PROFIBUS DP) EH (EtherCAT)

EW (POWERLINK) EI (EtherNet/IP) EP (PROFINET)

E-SW-*/PQ support: valves with SP, SF, SL alternated control (e.g. E-SW-BASIC/PQ)



WARNING: drivers USB port is not isolated!

Adapter, to be ordered separately :

E-A-PS-USB/IR = adapter from USB connector (PC communication port) to driver infrared communication interface: plug the adapter on the driver to establish the infrared communication

Connection

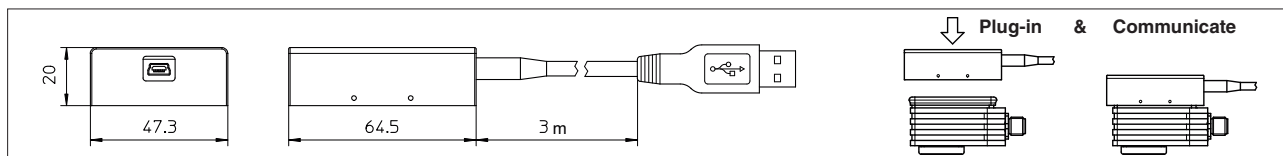
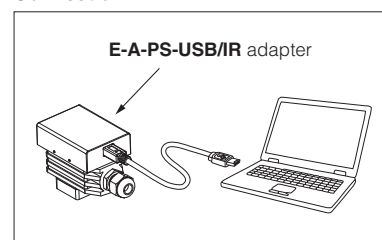

6 MAIN SOFTWARE PARAMETER SETTINGS

The following is a brief description of the main settings and features of digital drivers. For a detailed descriptions of available settings, wirings and installation procedures, please refer to the user manual included in the E-SW programming software:

E-MAN-MI-AS - user manual for **E-MI-AS-IR**

6.1 Scale

Scale function allows to set the maximum current supplied to the solenoid, corresponding to the max valve regulation, at maximum reference signal value.

This regulation allows to adapt the maximum current supplied from the driver to the specific nominal current of the proportional valves to which the driver is coupled; it is also useful to reduce the maximum valve regulation in front of maximum reference signal.

6.1, 6.2 - Scale, Bias & Threshold

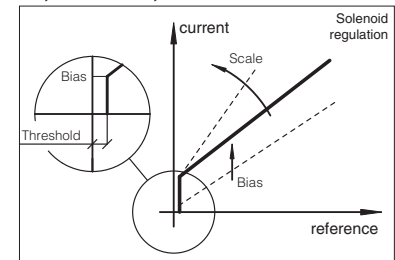

6.2 Bias and Threshold

Proportional valves may be provided with a dead band in the hydraulic regulation corresponding to their switch-off status.

This dead band discontinuity in the valve's regulation can be compensated by activating the Bias function, which adds a fixed preset Bias value to the reference signal (external input or internally generated).

The Bias function is activated when the reference signal overcome the Threshold value, preset into the driver.

The Bias setting allows to calibrate the Bias current supplied to the solenoid of the specific proportional valve to which the driver is coupled.

The Threshold setting is useful to avoid undesired valve regulation at zero reference signal when electric noise is present on the analog input signal: smaller threshold reduces the reference signal dead band, greater values are less affected by electric noise presence.

If internal reference generation is active (see 6.6), threshold should be set to 0.

6.3 - Ramps

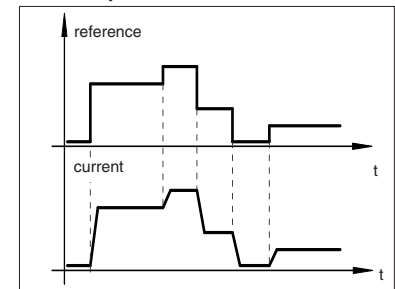

6.3 Ramps

The ramp generator allows to convert sudden change of electronic reference signal into smooth time-dependent increasing/decreasing of the current supplied to the solenoid.

Different ramp mode can be set:

- single ramp for any reference variation
- two ramps for increasing and for decreasing reference variations

Ramp generator is useful for application where smooth hydraulic actuation is necessary to avoid machine vibration and shocks.

If the proportional valve is driven by a closed loop controller, the ramps can lead to unstable behaviour, for these applications ramp function can be software disabled (default setting)

6.4 - Dither

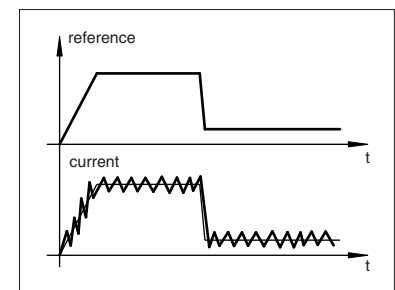

6.4 Dither

The dither is an high frequency modulation of the current supplied to the solenoid, to reduce the hysteresis of the valve's regulation: a small vibration in the valve's regulating parts considerably reduces static friction effects.

Dither frequency can be set in a range from 80 to 500 Hz (default value is 200Hz).

Lower dither setting reduces the hysteresis but also reduces the regulation stability. In some application this can lead to vibration and noise: right setting usually depends on system setup.

Default dither is a valid setting for a wide range of hydraulic applications

6.5 - Linearization

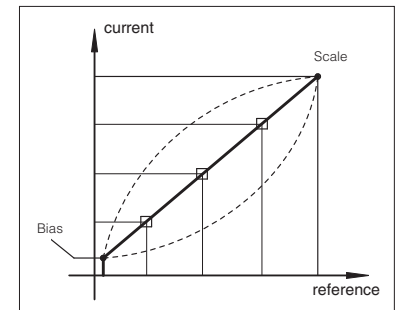

6.5 Linearization

Linearization function allows to set the relation between the reference input signal and the current supplied to the solenoid.

Linearization is useful for applications where it is required to linearize the valve's regulation in a defined working condition (e.g. maximum pressure control at defined working flow)

6.6 Internal Reference Generation

Internal generation of reference values is software selectable.

In this mode the 2 driver inputs (see 4.6) allow to select the desired solenoid current reference signal, among the different internal stored values: external control unit can thus manage complex machine profile by simple switching of the reference signal, by 2 digital inputs (see 4.6).

Each digital input combination corresponds to a different reference value; up to 4 different internal values are available:

	Internal generated references			
	REF1	REF2	REF3	REF4
CMD1	0	24 Vdc	24 Vdc	0
CMD2	0	0	24 Vdc	24 Vdc

A different ramp time value can be set by software for each available stored reference value.

6.7 Hydraulic Power Limitation (W option)

E-MI-AS drivers with W option electronically perform hydraulic power limitation on single solenoid valves:

- flow control valves (direct and pilot operated)
- directional control valves (direct and pilot operated) + mechanical pressure compensator
- variable displacement pumps with proportional flow regulator (e.g. PVPC-*-LQZ, tab. A170)

The driver receives the flow reference signal by the analog external input CMD1 (see 4.2) and a pressure transducer, installed in the hydraulic system, has to be connected to the driver's analog input CMD2 (see 4.3).

When the actual requested hydraulic power $p \times Q$ (CMD2 x CMD1) reaches the max power limit ($p_1 \times Q_1$), internally set by software, the driver automatically reduces the flow regulation of the valve. The higher is the pressure transducer feedback the lower is the valve's regulated flow:

6.6 - Internal Reference Generation

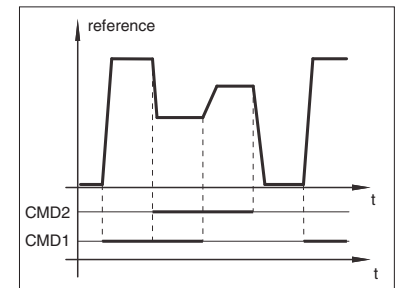

6.7 - Hydraulic Power Limitation

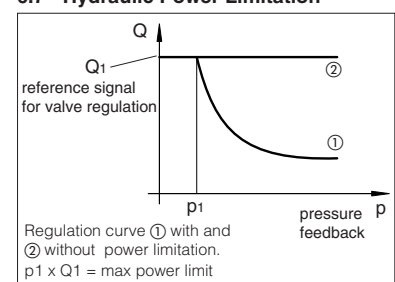

$$\text{Flow regulation} = \text{Min} \left(\frac{\text{PowerLimit [sw setting]}}{\text{Transducer Pressure [CMD2]}}; \text{Flow Reference [CMD1]} \right)$$

7 CONNECTIONS

Standard cable wire color	/M12 option pin	SIGNAL	TECHNICAL SPECIFICATIONS	NOTES
RED	1	V+	Power supply +24 V _{DC} or +12 V _{DC} (see 4.1)	Input - power supply
BLACK	2	V0	Power supply 0 V _{DC}	
WHITE	3	AGND (Signal zero)	Ground for CMD1, CMD2 and OUTPUT SUPPLY	Input - analog signal
GREEN	N.A.	OUTPUT SUPPLY	+5 V _{DC} @ 5 mA output supply for external potentiometer (not available for option /M12) (see 4.4)	Output - analog signal

The two input signals CMD1 and CMD2 can be managed as analog input or ON/OFF signals; their function depends on the selected software setting:

Standard cable wire color	/M12 option pin	SIGNAL	TECHNICAL SPECIFICATIONS (software setting dependent)			NOTES
			Default (see 4.2 ; 4.5)	Internal Reference Generation (see 4.6 ; 6.6)	Hydraulic Power Limitation (only for /W option - see 4.3 ; 6.7)	
YELLOW	4	CMD 1	Reference analog input: 0 ÷ 10 V _{DC} (4 ÷ 20 mA; 0 ÷ 20 mA for /I option)	ON/OFF: 24 V _{DC} / 0 V _{DC}	Reference analog input: 0 ÷ 10 V _{DC} (4 ÷ 20 mA; 0 ÷ 20 mA for option /I)	Input - analog or digital
BLUE	5	CMD 2	Enable/disable the driver: 24V _{DC} / 0V _{DC}	ON/OFF: 24 V _{DC} / 0 V _{DC}	Pressure transducer input: 0 ÷ 10 V _{DC}	

8 DOUBLE SOLENOID VALVES OPERATION

It is possible to use two E-MI-AS drivers to operate one double solenoid proportional valve supplying the same analog signal to both CMD1 inputs reference. The enable input signal is used to select which driver/solenoid has to be active.

To operate double solenoid valves it is required to:

- parallel wire the two drivers (see following scheme).
- select opposite polarity (default and reverse) for the two enable signals (see 4.5)
- manage from PLC or machine unit: 1 analog reference signal corresponding to desired valve's regulation and 1 ON/OFF signal to select the active solenoid.

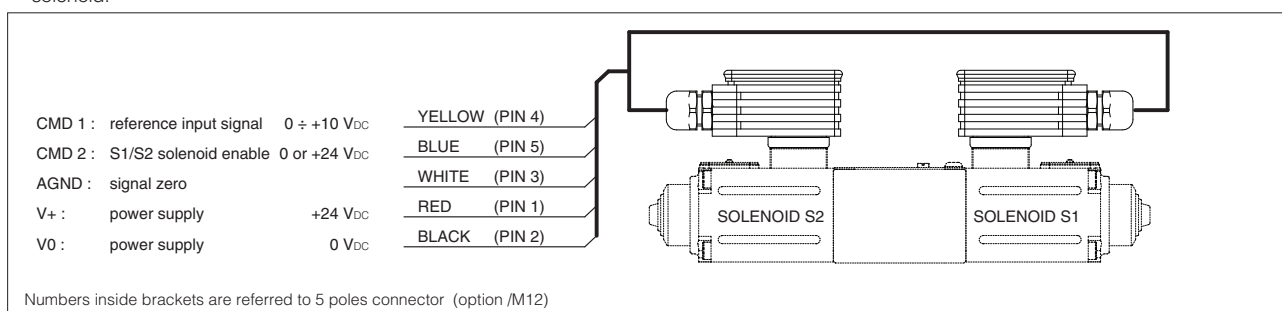

9 DIAGNOSTIC LEDS

It is possible to verify the actual status of solenoid command (yellow LED) and the driver status (green LED).

The following table details the possible displayed conditions:

COIL (YELLOW LED)	
Light signal displayed	Coil status
Light Off	PWM command OFF
Light On	PWM command ON
Slow blinking	Solenoid not connected
Fast blinking	Short circuit on the solenoid
STATUS (GREEN LED)	
Light signal displayed	Driver status
Light Off	Absence of power supply
Light On	Malfunctioning
Slow blinking	Driver disabled or Alarm present
Fast blinking	Driver enabled

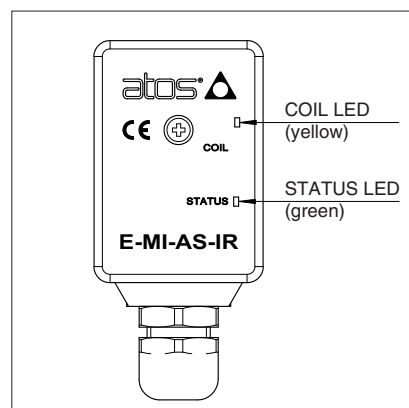

10 OVERALL DIMENSIONS [mm] AND INSTALLATION

