



60
kN

**DOUBLE
ROLLER/TAPPER
BEARING**

**HYDRAULIC INPUTS
FROM OPPOSITE
SIDES**

-50
kN

Ø80 Ø35
mm

R
1/2"
BSP

R
250
bar

GO/GC
1/2"
BSP

GO
250
bar

GC
300
bar

30
kN

-25
kN

1850
nm

39
kg

25
l/min

Hydraulic rotator FHR 6LD2/68 is ideal for professional use in forestry, agriculture, road and building construction, recycling industry, general cargo and material handling.



Rotator's upper mount is applied in FORK form factor of the knuckle joint. Robust and tough built to withstand even overloads. The fork width (between fork ends) is common standard width 80mm and the knuckle pin diameter 35mm.



FHL 02

Rotator lower mount is applied in AXLE form factor to mount in grapple / tool mounting tube or adaptor and by fixing with pin. Axle (shaft) diameter is 68mm and the fixing pin (not included) diameter 30mm

Ø68 Ø30
mm

GO/GC
1/2"
BSP

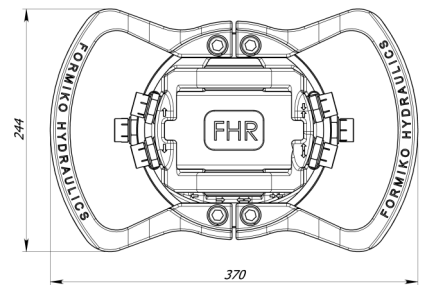
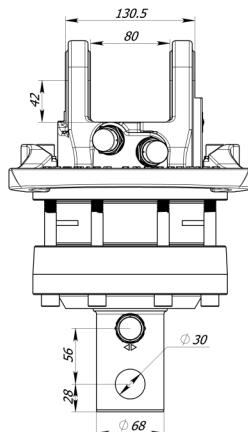
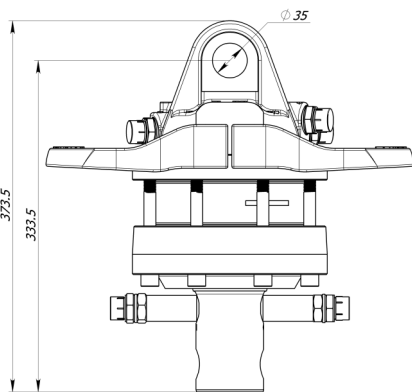

For additional information relating to price levels and technical data, please contact sales@formiko.lv

Formiko Hydraulic s Ltd

Dzirciema Str. 119 k-1,
Rīga LV1055 LATVIA

+371 294 49 552
+371 264 59 383
sales@formiko.lv
www.formiko.lv

On request by special conditions there are metric nipples available for rotator FHR 6LD2/68







Hydraulic rotator FHR 6LD2/68 is ideal for professional use in forestry, agriculture, road and building construction, recycling industry, general cargo and material handling.

 Rotator's upper mount is applied in FORK form factor of the knuckle joint. Robust and tough built to withstand even overloads. The fork width (between fork ends) is common standard width 80mm and the knuckle pin diameter 35mm.

 Rotator lower mount is applied in AXLE form factor to mount in grapple / tool mounting tube or adaptor and by fixing with pin. Axle (shaft) diameter is 68mm and the fixing pin (not included) diameter 30mm

 Rotator FHR 6LD2/68 based on reliable vane type hydraulic motor which delivers torque up to 1850Nm at 25MPa.

 Formiko Hydraulics rotator FHR 6LD2/68 is equipped with double bearings to withstand both tensional and pushing loads.

 FHR 6LD2/68 is designed with opposite hydraulic channels, to ease the hose replacement in case of rupture.

 Formiko rotator FHR 6LD2/68 is compatible with FHL 02 series links.

 Rotator for shipping is packed in compact solid cardboard box with dimensions 400x250x250mm.

 We providing TWO year warranty for this rotator.

For additional information relating to price levels and technical data, please contact sales@formiko.lv

Formiko Hydraulic s Ltd

Dzirciema Str. 119 k-1,
Riga LV1055 LATVIA

+371 294 49 552
+371 264 59 383
sales@formiko.lv
www.formiko.lv

On request by special conditions there are metric nipples
available for rotator FHR 6LD2/68

