

# RLM3

## ELECTRIC FAST / SLOW SPEED SELECTION VALVE SERIES 10



### MODULAR VERSION ISO 4401-03

**p** max 250 bar  
**Q** max (see table of performances)

### MOUNTING SURFACE

ISO 4401-03 -02-0-05  
(CETOP 4.2-4-03-250)

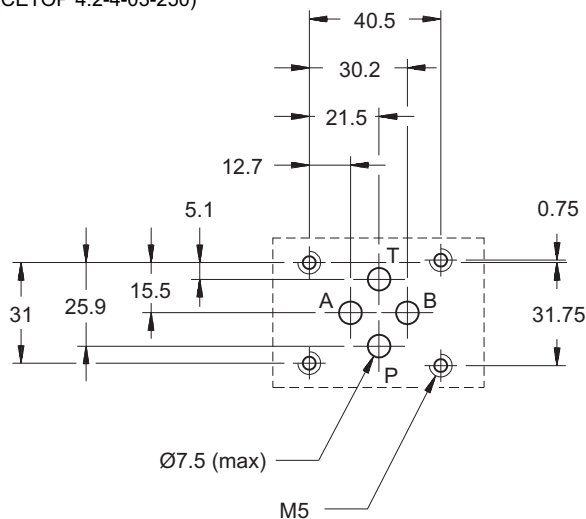

### OPERATING PRINCIPLE

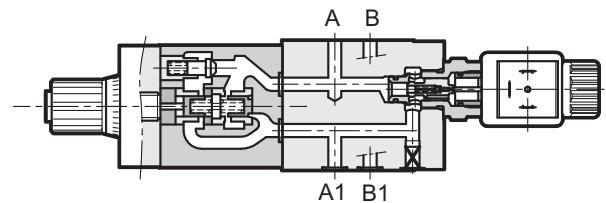

- The RLM3 valve is a compact group that allows control of the fast/slow flow through use of an open/close solenoid valve. The adjustment of the flow is carried out with the RPC1 compensated flow control valves (see catalogue 32 200) with six adjustment ranges.
- The fast/slow speed selection is obtained with the KT08 solenoid cartridge poppet valve (see catalogue 43 100).
- Made as a modular version, the mounting surface is according to iso 4401 standards.
- The RLM3 valve can be assembled quickly under ISO 4401-03 directional solenoid valves without use of pipes, permitting the construction of directional and speed controls for actuators in a single work-station.

### PERFORMANCES

(measured with mineral oil of viscosity 36cSt at 50°C)

Maximum operating pressure	bar	250
Maximum flow rate in controlled lines Maximum flow rate in the free lines	l/min	1 - 4 - 10 - 16 - 22 - 30 65
Minimum controlled flow rate	l/min	0,025
Ambient temperature range	°C	-20 / +50
Fluid temperature range	°C	-20 / +80
Fluid viscosity range	cSt	10 ÷ 400
Fluid contamination degree	According to ISO 4406:1999 class 20/18/15	
Recommended viscosity	cSt	25
Mass	kg	3,1

### CONFIGURATIONS

(see hydraulic symbols)

- Configuration "A": meter-out control from the actuator on chamber A.
- Configuration "T": control on discharge T of the directional solenoid valve for speed control in both directions of movement.

## 1 - IDENTIFICATION CODE

<b>R</b>	<b>L</b>	<b>M</b>	<b>3</b>	<b>-</b>		<b>/</b>	<b>10</b>	<b>-</b>		<b>/</b>	
----------	----------	----------	----------	----------	--	----------	-----------	----------	--	----------	--

Electric fast/ slow speed selection valve

Modular version

Size ISO 4401-03

Adjustments:  
**A** = adjustment on chamber A of the actuator;  
**T** = adjustment on discharge T of the directional solenoid valve

**A** = normally open solenoid valve  
**C** = normally closed solenoid valve

Flow adjustment range:  
**01** = 1 l/min      **16** = 16 l/min  
**04** = 4 l/min      **22** = 22 l/min  
**10** = 10 l/min     **30** = 30 l/min

Series No. (the overall and mounting dimensions remain unchanged from 10 to 19)

See **NOTE 2**

Coil electrical connection: (see paragraph 10)  
**K1** = plug for connector type EN 175301-803 (ex DIN 43650) (**standard**)

For **DC** supply only:  
**K2** = plug for connector type AMP JUNIOR  
**K4** = outgoing cables  
**WK7** = plug DEUTSCH DT04-2P for male connector type DEUTSCH DT06-2S  
**WK8** = plug for connector type AMP SUPER SEAL

Coil type:  
**D12** = 12 V } direct current (**standard**)  
**D24** = 24 V }  
**R110** = 110 V } rectified current  
**R230** = 230 V }  
**D00** = valve without coil (see **NOTE 1**)

Seals:  
**N** = NBR for mineral oils  
**V** = viton for special fluids

**NOTE 1:** The coil locking ring and the relevant seals are included in the supply.  
**NOTE 2:** The manual override **CM** is available as an option (see paragraph 8).

**N.B. :** For further information about the flow control valve see catalogue 32 200; for further information about the cartridge poppet valve see catalogue 43 100.

### 1.1 - Coil identification code

<b>C</b>	<b>14</b>	<b>L3</b>	<b>-</b>		<b>/</b>	<b>10</b>
----------	-----------	-----------	----------	--	----------	-----------

Power supply

**D12** = 12 V } direct current  
**D24** = 24 V } (**standard**)  
**R110** = 110 V } rectified current  
**R230** = 230 V }

Series no.: (the overall and mounting dimensions remain unchanged from 10 to 19)

Coil electrical connection (see paragraph 10)  
**K1** = plug for connector type EN 175301-803 (ex DIN 43650) (**standard**)

For **D12** and **D24** coils only:  
**K2** = plug for connector type AMP JUNIOR  
**K4** = outgoing cables  
**WK7** = plug DEUTSCH DT04-2P for male connector type DEUTSCH DT06-2S  
**WK8** = plug for connector type AMP SUPER SEAL

## 2 - HYDRAULIC FLUIDS

Use mineral oil-based hydraulic fluids HL or HM type, according to ISO 6743-4. For these fluids, use NBR seals (code N). For fluids HFDR type (phosphate esters) use FPM seals (code V). For the use of other kinds of fluid such as HFA, HFB, HFC, please consult our technical department.

Using fluids at temperatures higher than 80 °C causes a faster degradation of the fluid and of the seals characteristics. The fluid must be preserved in its physical and chemical characteristics.

### 3 - HYDRAULIC SYMBOLS

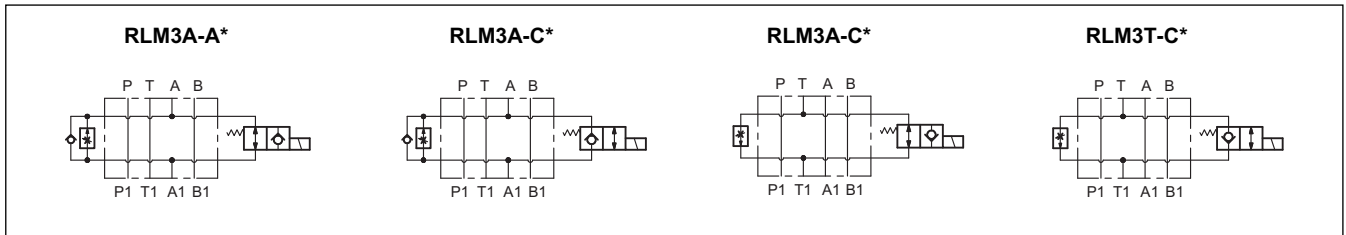

### 4 - PRESSURE DROPS $\Delta P-Q$

(obtained with viscosity of 36 cSt at 50 °C)

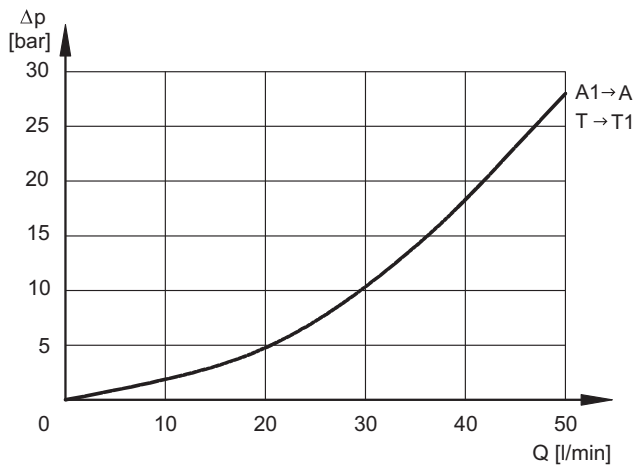

The values in graphs refer to the fast flow through the solenoid valve and are equal for A (normally open) and C (normally closed) versions.

### 5 - SWITCHING TIME

The values are obtained according to the ISO 6403 standard, with mineral oil at 50°C, with viscosity of 36 cSt.

TIMES [ms]	ENERGIZING	DE-ENERGIZING
<b>RLM3*-A*</b>	85	60
<b>RLM3*-C*</b>	60	85

### 6 - OPERATING LIMITS

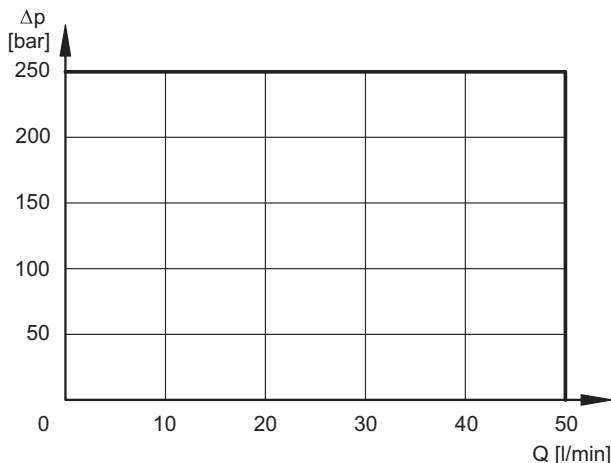

The curves define the flow rate operating fields according to the valve pressure of the different versions.

The values have been obtained according to ISO 6403 norm with solenoids at rated temperature and supplied with voltage equal to 90% of the nominal voltage.

The value have been obtained with mineral oil, viscosity 36 cSt, temperature 50 °C and filtration according to ISO 4406:1999 class 18/16/13.

### 7 - ELECTRICAL FEATURES

#### 7.1 - Solenoids

These are essentially made up of two parts: tube and coil. The tube is threaded onto the valve body and includes the armature that moves immersed in oil, without wear. The inner part, in contact with the oil in the return line, ensures heat dissipation. The coil is fastened to the tube by a threaded nut, and can be rotated according to the available space.

The interchangeability of coils of different voltages both D or R type is possible without removing the tube.

#### Protection from atmospheric agents IEC 60529

The IP protection degree is intended for the whole valve. It is guaranteed only with both valve and connector of an equivalent IP degree, correctly connected and installed.

Versions with CM manual override are IP65 always.

Electric connection	IP65	IP66	IP67	IP68	IP69 IP69K (*)
K1 EN 175301-803	x	x			
K2 AMP JUNIOR	x		x		
K4 outgoing cables	x				
WK7 DEUTSCH DT04 male	x		x	x	x
WK8 AMP SUPER SEAL	x	x	x	x	x

(\*) The protection degree IP69K is not taken into account in IEC 60529 but it is included in both ISO 20653.

<b>SUPPLY VOLTAGE FLUCTUATION</b>	± 10% Vnom
<b>MAX SWITCH ON FREQUENCY</b>	10.000 ins/hr
<b>DUTY CYCLE</b>	100%
<b>ELECTROMAGNETIC COMPATIBILITY (EMC)</b>	In compliance with 2014/30/EU
<b>LOW VOLTAGE</b>	In compliance with 2014/35/EU
<b>CLASS OF PROTECTION :</b> Coil insulation (VDE 0580) Impregnation:	class H class H

#### 7.2 - Current and absorbed power

In the table are shown current and power consumption values relevant to the different coil types. "R" coil must be used when the valve is fed with AC power supply subsequently rectified by means of rectifier bridge, externally or incorporated in the "D" type connector (see cat. 49 000).

	Resistance at 20°C [Ω] (±1%)	Absorbed current [A] (±5%)	Absorbed power (±5%)		Coil code				
			[W]	[VA]	K1	K2	K4	WK7	WK8
<b>D12</b>	5,4	2,2	26,5		1902740	1902750	1902770	1903510	1903520
<b>D24</b>	20,7	1,16	27,8		1902741	1902751	1902771	1903511	1903521
<b>R110</b>	363	0,25		27,2	1902742				
<b>R230</b>	1640	0,11		26,4	1902743				

### 8 - MANUAL OVERRIDE

CM for NO version (pushing type)

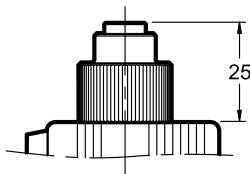

CM for NC version (screw type)

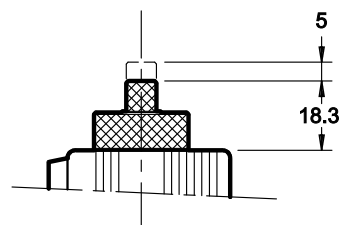

## 9 - OVERALL AND MOUNTING DIMENSIONS

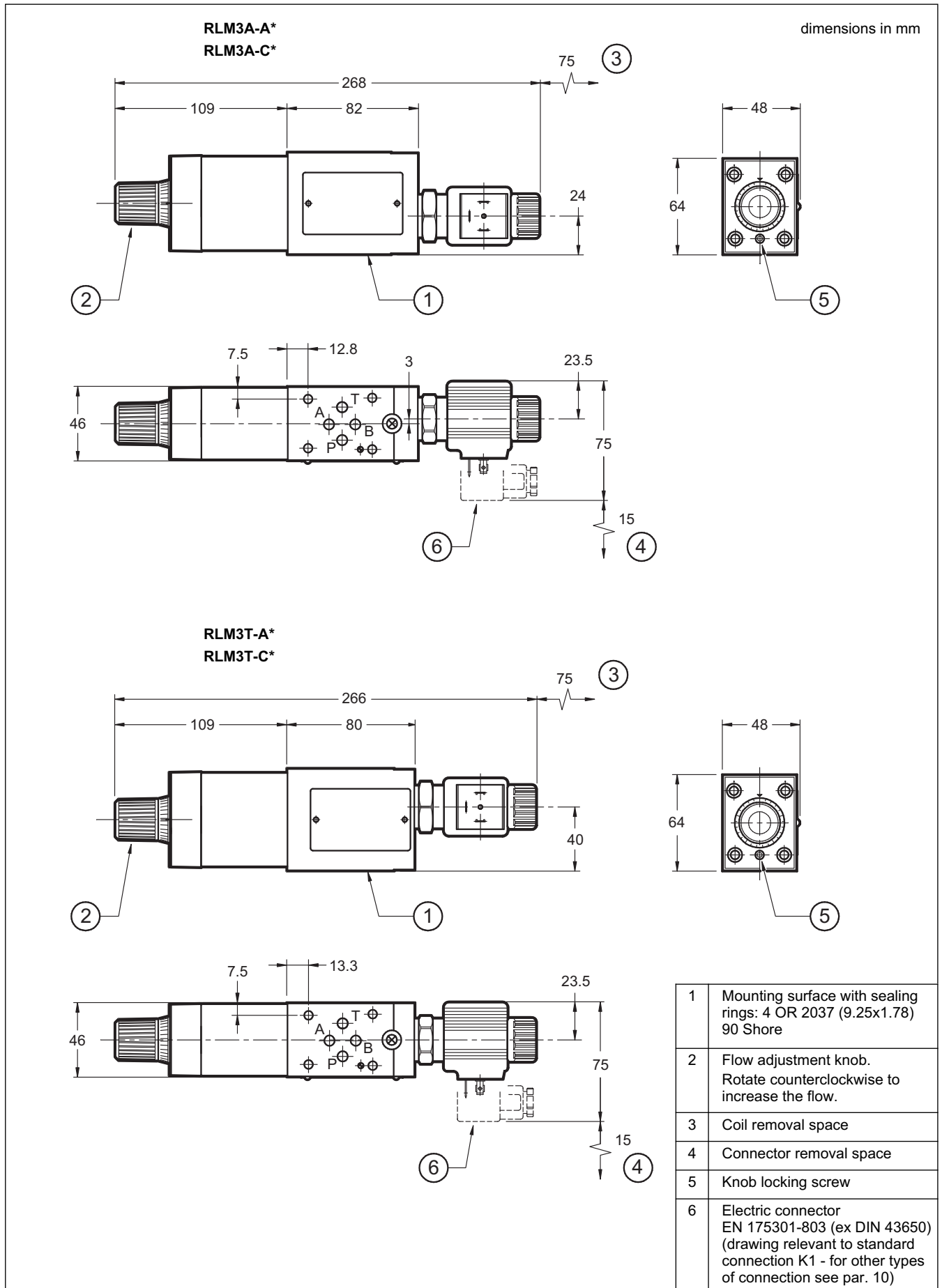



## 10 - ELECTRIC CONNECTIONS

connection for EN 175301-803  
(ex DIN 43650) connector type  
code **K1 (standard)**

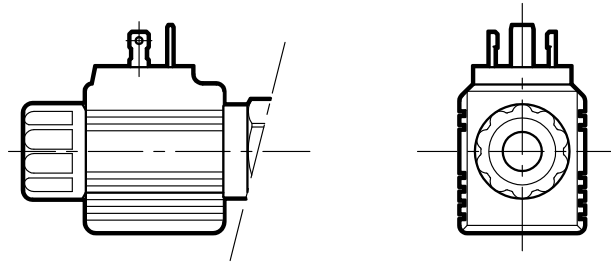

connection for AMP JUNIOR  
connector type  
code **K2**

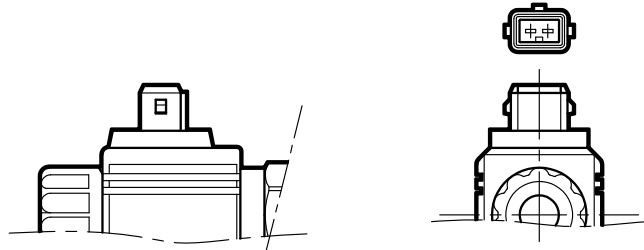

outgoing cable connections  
cable length = 1 mt  
code **K4**



connection for DEUTSCH DT04-2P  
for male connector type DEUTSCH DT06  
code **WK7**

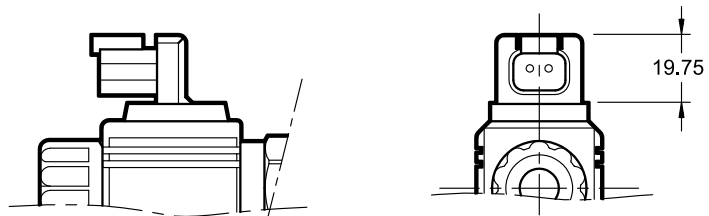

connection for AMP SUPER SEAL  
(two contacts) connector type  
code **WK8**

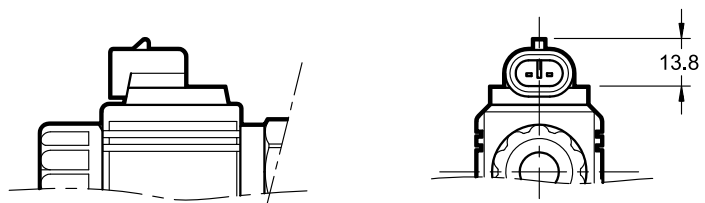

## 11 - ELECTRIC CONNECTORS

Solenoid valves are delivered without connectors. Connectors type EN 175301-803 (ex DIN 43650) for K1 connection can be ordered separately. See catalogue 49 000.