

Ex-proof proportional relief valves

direct or piloted, without transducer - **ATEX, IECEx, EAC, PESO** or **cULus**

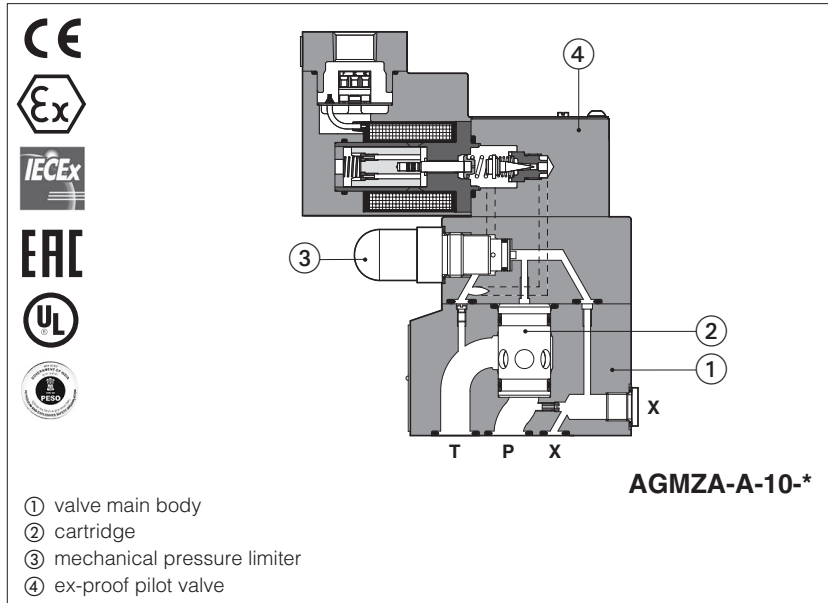

RZMA-A, HZMA-A, AGMZA-A

Ex-proof proportional relief valves direct or piloted, without transducer for open loop pressure controls.

They are equipped with ex-proof proportional solenoid, certified for safe operations in hazardous environments with potentially explosive atmosphere.

Certifications:

- Multicertification **ATEX, IECEx, EAC** and **PESO** for gas group **II 2G** and dust category **II 2D**
- Multicertification **ATEX** and **IECEx** for gas group **I M2** (mining)
- **cULus** North American certification for gas group **C&D**

RZMA, direct or piloted:
Size: **06** - ISO 4401
Max flow: **4** and **40 l/min**

HZMA, direct or piloted:
Size: **06** - ISO 4401
Max flow: **40 l/min**

AGMZA, piloted:
Size: **10, 20** and **32** - ISO 6264
Max flow: **200, 400** and **600 l/min**

Max pressure: **250 bar**

1 MODEL CODE

RZMA	/	*	-	A	-	10	-	250	/	GK	/	*	/	*	*	*																
<p>Ex-proof proportional pressure relief valves</p> <p>RZMA = subplate size 06 HZMA = modular size 06 AGMZA = subplate size 10, 20, 32</p> <p>Certification type: Multicertification: - = omit for Group II 2G / 2D (1) M = Group I M2 (mining) North American Certification: UL = cULus</p> <p>A = without transducer</p> <p>Valve size and configuration:</p> <table border="0"> <tr> <td>010 = RZMA direct</td> <td>size 06</td> <td>Qmax 4 l/min</td> </tr> <tr> <td>030 = RZMA piloted</td> <td>size 06</td> <td>Qmax 40 l/min</td> </tr> <tr> <td>030 = HZMA piloted</td> <td>size 06</td> <td>Qmax 40 l/min</td> </tr> <tr> <td>10 = AGMZA piloted</td> <td>size 10</td> <td>Qmax 200 l/min</td> </tr> <tr> <td>20 = AGMZA piloted</td> <td>size 20</td> <td>Qmax 400 l/min</td> </tr> <tr> <td>32 = AGMZA piloted</td> <td>size 32</td> <td>Qmax 600 l/min</td> </tr> </table> <p>Max regulated pressure: 80 = 80 bar 180 = 180 bar 250 = 250 bar</p>															010 = RZMA direct	size 06	Qmax 4 l/min	030 = RZMA piloted	size 06	Qmax 40 l/min	030 = HZMA piloted	size 06	Qmax 40 l/min	10 = AGMZA piloted	size 10	Qmax 200 l/min	20 = AGMZA piloted	size 20	Qmax 400 l/min	32 = AGMZA piloted	size 32	Qmax 600 l/min
010 = RZMA direct	size 06	Qmax 4 l/min																														
030 = RZMA piloted	size 06	Qmax 40 l/min																														
030 = HZMA piloted	size 06	Qmax 40 l/min																														
10 = AGMZA piloted	size 10	Qmax 200 l/min																														
20 = AGMZA piloted	size 20	Qmax 400 l/min																														
32 = AGMZA piloted	size 32	Qmax 600 l/min																														
<p>Seals material, see section 7: - = NBR PE = FKM BT = HNBR (2)</p> <p>Series number</p> <p>Voltage code: - = standard coil for 24 Vdc Atos drivers 24 = optional coil for 24 Vdc low current drivers</p> <p>Options (3): E = external pilot (only for AGMZA) O = horizontal cable entrance (2) Y = external drain (only for AGMZA)</p> <p>Solenoid threaded connection for cable gland fitting: GK = GK-1/2" - not for cULus (4) M = M20x1,5 - not for cULus NPT = 1/2" NPT</p>																																

(1) The valves with Multicertification for Group II are also certified for Indian market according to **PESO** (Petroleum and Explosives Safety Organization). The PESO certificate can be downloaded from www.atos.com

(2) Not for multicertification **M** group I (mining) **(3)** Possible combined options: /EO, /EY, /OY **(4)** Approved only for the Italian market

⚠ The pressure at T port makes difficult the manual override operation that can be possible only if its value is lower than 50 bar

2 CONFIGURATIONS AND HYDRAULIC SYMBOLS (representation according to ISO 1219-1)

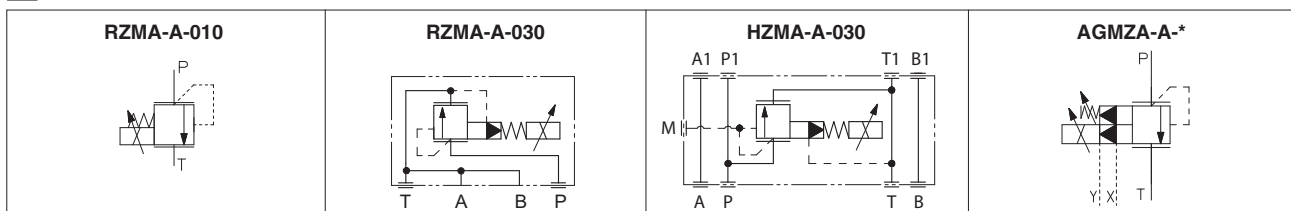

3 ELECTRONIC DRIVERS

Electronic drivers are factory set with max current limitation for ex-proof valves.

Please include in the driver order also the complete code of the connected ex-proof proportional valve.

Drivers model	E-BM-AS-* /A	E-BM-AES-* /A
Type	digital	digital
Format	DIN-rail panel	
Data sheet	G030	GS050

4 GENERAL CHARACTERISTICS

Assembly position	Any position
Subplate surface finishing to ISO 4401	Acceptable roughness index, Ra ≤0,8 recommended Ra 0,4 - flatness ratio 0,01/100
MTTFd valves according to EN ISO 13849	75 years; 150 years only for RZMA-010, see technical table P007
Ambient temperature range	Standard = -20°C ÷ +70°C /PE option = -20°C ÷ +70°C /BT option = -40°C ÷ +70°C
Storage temperature range	Standard = -20°C ÷ +80°C /PE option = -20°C ÷ +80°C /BT option = -40°C ÷ +70°C
Surface protection	Zinc coating with black passivation - salt spray test (EN ISO 9227) > 200h
Compliance	Explosion proof protection, see section 8 -Flame proof enclosure "Ex d" -Dust ignition protection by enclosure "Ex t" RoHs Directive 2011/65/EU as last update by 2015/65/EU REACH Regulation (EC) n°1907/2006

5 HYDRAULIC CHARACTERISTICS - based on mineral oil ISO VG 46 at 50 °C

Valve model	RZMA		HZMA	AGMZA		
	010	030	030	10	20	32
Size code						
Valve size	06			10	20	32
Max regulated pressure [bar]	80			180	250	
Min regulated pressure [bar]	see min. pressure / flow diagrams at sections 15 16 17					
Max pressure at port P, A, B, X [bar]	315					
Max pressure at port T, Y [bar]	210					
Max flow [l/min]	4	40	40	200	400	600
Response time 0-100% step signal (depending on installation) (1) [ms]	≤ 80			≤ 130	≤ 145	≤ 160
Hysteresis[% of the max pressure]	≤ 1,5					
Linearity[% of the max pressure]	≤ 3					
Repeatability[% of the max pressure]	≤ 2					

Note: above performance data refer to valves coupled with Atos electronic drivers, see section 3

(1) Average response time value; the pressure variation in consequence of a modification of the reference input signal to the valve is affected by the stiffness of the hydraulic circuit: greater is the stiffness of the circuit, faster is the dynamic response

6 ELECTRICAL CHARACTERISTICS

Max. power	35W	
Insulation class	H (180°) Due to the occurring surface temperatures of the solenoid coils, the European standards ISO 13732-1 and EN982 must be taken into account	
Protection degree with relevant cable gland	Multicertification: IP66/67 to DIN EN60529 UL: raintight enclosure, UL approved	
Duty factor	Continuous rating (ED=100%)	
Voltage code	standard	option /24
Coil resistance R at 20°C	3,2 Ω	17,6 Ω
Max. solenoid current	2,5 A	1,1 A

7 SEALS AND HYDRAULIC FLUIDS - for other fluids not included in below table, consult our technical office

Seals, recommended fluid temperature	NBR seals (standard) = -20°C ÷ +60°C, with HFC hydraulic fluids = -20°C ÷ +50°C FKM seals (/PE option) = -20°C ÷ +80°C HNBR seals (/BT option) = -40°C ÷ +60°C, with HFC hydraulic fluids = -40°C ÷ +50°C		
Recommended viscosity	20 ÷ 100 mm ² /s - max allowed range 15 ÷ 380 mm ² /s		
Max fluid contamination level	normal operation	ISO4406 class 18/16/13 NAS1638 class 7	see also filter section at www.atos.com or KTF catalog
	longer life	ISO4406 class 16/14/11 NAS1638 class 5	
Hydraulic fluid	Suitable seals type	Classification	Ref. Standard
Mineral oils	NBR, FKM, HNBR	HL, HLP, HLPD, HVLP, HVLPD	DIN 51524
Flame resistant without water	FKM	HFDU, HFDR	ISO 12922
Flame resistant with water (1)	NBR, HNBR	HFC	

⚠ The ignition temperature of the hydraulic fluid must be 50°C higher than the max solenoid surface temperature

(1) Performance limitations in case of flame resistant fluids with water:

- max operating pressure = 210 bar
- max fluid temperature = 50°C

8 CERTIFICATION DATA

Valve type	RZMA, HZMA, AGMZA		RZMA/M, HZMA/M, AGMZA/M	RZMA/UL, HZMA/UL, AGMZA/UL	
Certifications	Multicertification Group II ATEX IECEX EAC PESO		Multicertification Group I ATEX IECEX	North American cULus	
Solenoid certified code	MZA-A		MZAM-A	OZA-A/EC	
Type examination certificate (1)	ATEX: CESI 02 ATEX 014 IECEX: IECEX CES 10.0010x EAC: TC RU C-IT. 08.B.01784 PESO: P338131		ATEX: CESI 03 ATEX 057x IECEX: IECEX CES 12.0007x	20170324 - E366100	
Method of protection	<ul style="list-style-type: none"> • ATEX, EAC Ex II 2G Ex d IIC T4/T3 Gb Ex II 2D Ex tb IIIC T135°C/T200°C Db • IECEX Ex d IIC T4/T3 Gb Ex tb IIIC T135°C/T200°C Db • PESO Ex II 2G Ex d IIC T4/T3 Gb 		<ul style="list-style-type: none"> • ATEX 2014/34/EU Ex I M2 Ex db I Mb • IECEX Ex db I Mb 	<ul style="list-style-type: none"> • UL 1203 Class I, Div.I, Groups C & D Class I, Zone I, Groups IIA & IIB 	
Temperature class	T4	T3	-	T4	T3
Surface temperature	≤ 135 °C	≤ 200 °C	≤ 150 °C	≤ 135 °C	≤ 200 °C
Ambient temperature (2)	-40 ÷ +40 °C	-40 ÷ +70 °C	-20 ÷ +60 °C	-40 ÷ +55 °C	-40 ÷ +70 °C
Applicable standards	EN 60079-0: 2012+A11:2013 EN 60079-1:2014 EN 60079-31:2014		IEC 60079-0:2017 IEC 60079-1:2017-04 IEC 60079-31:2013	UL 1203 and UL429, CSA 22.2 n°30-1986 CSA 22.2 n°139-13	
Cable entrance: threaded connection vertical (standard) or horizontal (option /O)			GK = GK-1/2" M = M20x1,5 NPT = 1/2" NPT	1/2" NPT	

(1) The type examiner certificates can be downloaded from www.atos.com

(2) The solenoids **Group II** and **cULus** are certified for minimum ambient temperature -40°C
In case the complete valve must withstand with minimum ambient temperature of -40°C, select **/BT** in the model code

⚠ WARNING: service work performed on the valve by the end users or not qualified personnel invalidates the certification

9 EX PROOF SOLENOIDS WIRING

Multicertification

Standard version **Option /O**

① cover with threaded connection for vertical cable gland fitting
② cover with threaded connection for horizontal cable gland fitting
③ terminal board for cables wiring
④ screw terminal for additional equipotential grounding

cULus certification

Standard version **Option /O**

① cover with threaded connection for vertical cable gland fitting
② cover with threaded connection for horizontal cable gland fitting
③ terminal board for cables wiring

⚠ Pay attention to respect the polarity

alternative GND screw terminal connected to solenoid housing

10 CABLE SPECIFICATION AND TEMPERATURE - Power supply and grounding cables have to comply with following characteristics:

Multicertification Group I and Group II	
Power supply: section of coil connection wires = 2,5 mm ²	Grounding: section of internal ground wire = 2,5 mm ² section of external ground wire = 4 mm ²
cULus certification:	
<ul style="list-style-type: none"> • Suitable for use in Class I Division 1, Gas Groups C • Armored Marine Shipboard Cable which meets UL 1309 • Tinned Stranded Copper Conductors • Bronze braided armor • Overall impervious sheath over the armor 	
Any Listed (UBVZ/UBVZ7) Marine Shipboard Cable rated 300 V min, 15A min. 3C 2,5 mm ² (14 AWG) having a suitable service temperature range of at least -25°C to +110°C ("BT" Models require a temperature range from -40°C to +110°C)	
Note 1: For Class I wiring the 3C 1,5 mm ² AWG 16 cable size is admitted only if a fuse lower than 10 A is connected to the load side of the solenoid wiring.	

10.1 Cable temperature

The cable must be suitable for the working temperature as specified in the "safety instructions" delivered with the first supply of the products.

Multicertification

Max ambient temperature [°C]	Temperature class		Max surface temperature [°C]		Min. cable temperature [°C]	
	Goup I	Goup II	Goup I	Goup II	Goup I	Goup II
40 °C	-	T4	150 °C	-	90 °C	-
45 °C	-	T4	150 °C	135 °C	-	90 °C
55 °C	-	T3	150 °C	200 °C	-	110 °C
60 °C	-	-	150 °C	-	110 °C	-
70 °C	N.A.	T3	N.A.	200 °C	N.A.	120 °C

cULus certification

Max ambient temperature [°C]	Temperature class	Max surface temperature [°C]	Min. cable temperature
55 °C	T4	135 °C	100 °C
70 °C	T3	200 °C	100 °C

11 CABLE GLANDS - only **Multicertification**

Cable glands with threaded connections GK-1/2", 1/2"NPT or M20x1,5 for standard or armoured cables have to be ordered separately, see tech. table **KX600**

Note: a Loctite sealant type 545, should be used on the cable gland entry threads

12 OPTIONS

For alla valves:

O = Horizontal cable entrance to be selected in case of limited vertical space.

Only for AGMZA:

E = External pilot option to be selected when the pilot pressure is supplied from a different line respect to the P main line.
With option E the internal connection between port P and X of the valve is plugged.
The pilot pressure must be connected to the X port available on the valve's mounting surface or on main body (threaded pipe connection G 1/4").

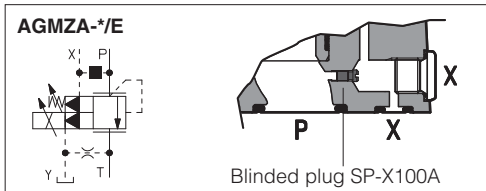

Only for AGMZA:

Y = The external drain is mandatory in case the main line T is subjected to pressure peaks or it is pressurized.
The Y drain port has a threaded connection G 1/4" available on the pilot stage body.

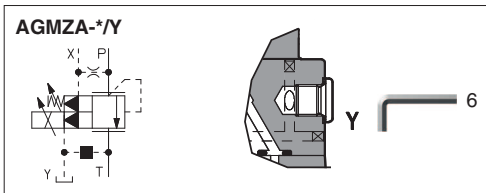

12.1 Possible combined options: /EO, /EY, /OY

13 MECHANICAL PRESSURE LIMITER - only for AGMZA

The AGMZA are provided with mechanical pressure limiter acting as protection against overpressure. For safety reasons the factory setting of the mechanical pressure limiter is fully unloaded (min pressure).

At the first commissioning it must be set at a value lightly higher than the max pressure regulated with the proportional control.

For the pressure setting of the mechanical pressure limiter, proceed according to following steps:

- apply the max reference input signal to the valve's driver. The system pressure will not increase until the mechanical pressure limiter remains unloaded.
- turn clockwise the adjustment screw ① until the system pressure will increase up to a stable value corresponding to the pressure setpoint at max reference input signal.
- turn clockwise the adjustment screw ① of additional 1 or 2 turns to ensure that the mechanical pressure limiter remains closed during the proportional valve working.

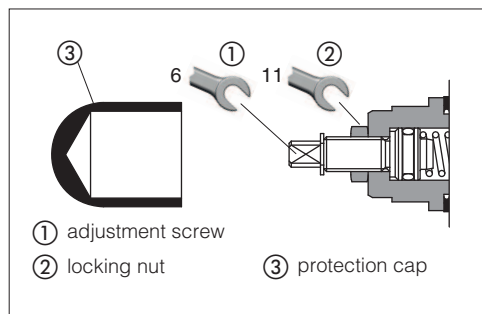

14 REMOTE PRESSURE UNLOADING - only for AGMZA

The **P** main line can be remotely unloaded by connecting the valve X port to a solenoid valve as shown in the below scheme (venting valve).

This function can be used in emergency to unload the system pressure by by-passing the proportional control.

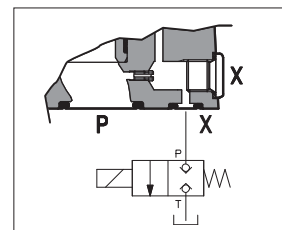

15 DIAGRAMS RZMA-010 (based on mineral oil ISO VG 46 at 50 °C)

1 Regulation diagrams
with flow rate $Q = 1$ l/min

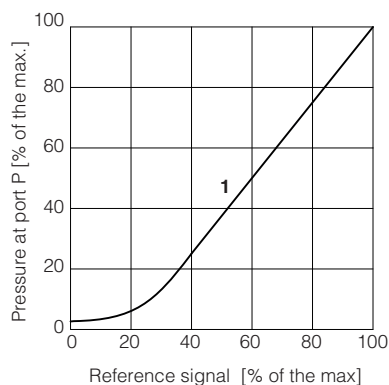

2 Pressure/flow diagrams
with reference signal set at $Q = 1$ l/min

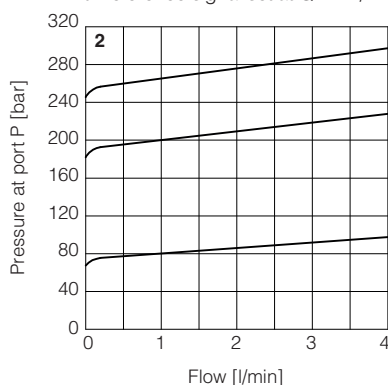

3-5 Min. pressure/flow diagrams
with zero reference signal

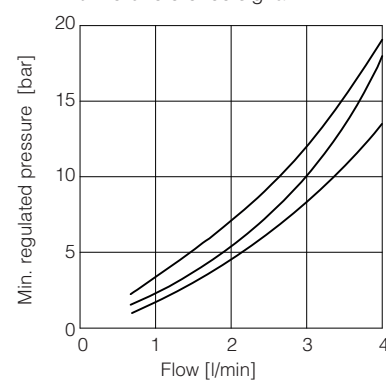

3 = RZMA/80
4 = RZMA/180
5 = RZMA/250

Note: the presence of counter pressure at port T can affect the pressure regulation and the minimum pressure

16 DIAGRAMS RZMA-030, HZMA-030 (based on mineral oil ISO VG 46 at 50 °C)

1 Regulation diagrams
with flow rate $Q = 10$ l/min

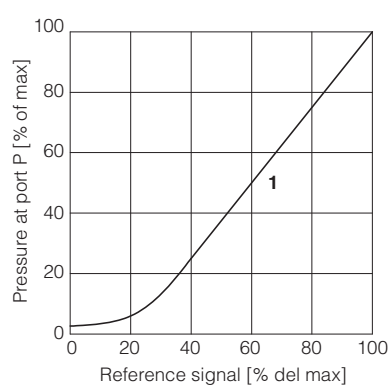

2 Pressure/flow diagrams
with reference signal set at $Q = 10$ l/min

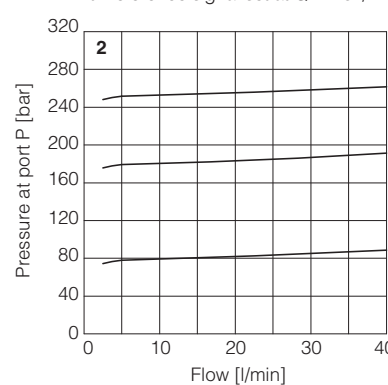

3 Min. pressure/flow diagrams
with zero reference signal

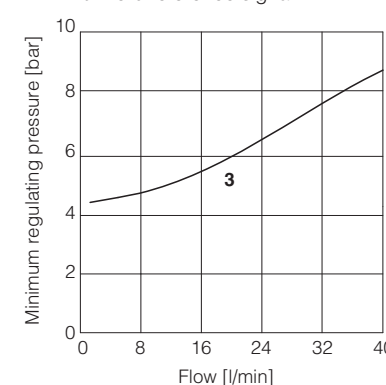

Note: the presence of counter pressure at port T can affect the pressure regulation and the minimum pressure

17 DIAGRAMS AGMZA (based on mineral oil ISO VG 46 at 50 °C)

1 = Regulation diagrams
with flow rate Q = 50 l/min

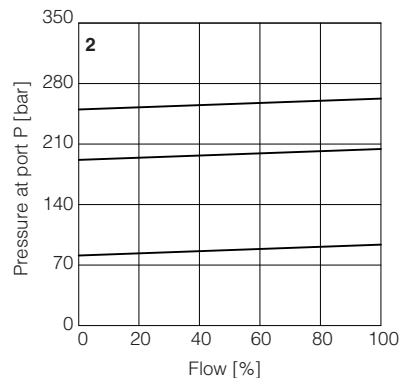
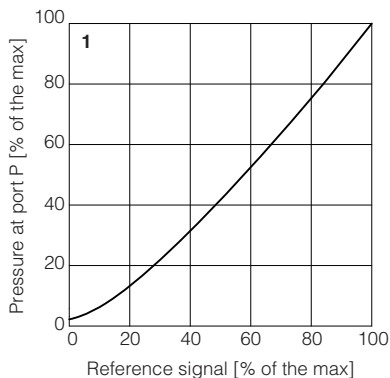

2 = Pressure/flow diagrams
with reference signal set at Q = 50 l/min

3-5 = Min. pressure/flow diagrams
with zero reference signal

- 3 = AGMZA-*-10
- 4 = AGMZA-*-20
- 5 = AGMZA-*-32

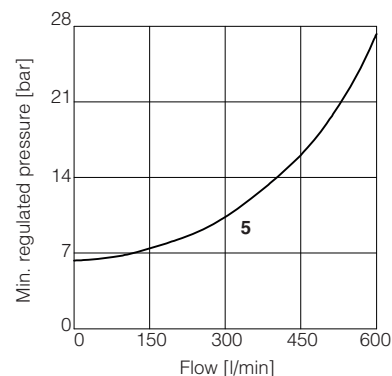
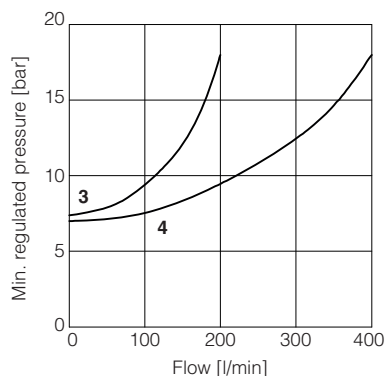

18 FASTENING BOLTS AND SEALS

18.1 RZMA and HZMA valves

	RZMA-A-010	RZMA-A-030	HZMA-A-030
	Fastening bolts: 4 socket head screws M5x50 class 12.9 Tightening torque = 8 Nm	Fastening bolts: 4 socket head screws M5x50 class 12.9 Tightening torque = 8 Nm	Fastening bolts: 4 socket head screws M5 class 12.9 Tightening torque = 8 Nm
	Seals: 2 OR 108 Diameter of ports P, T: Ø 5 mm	Seals: 4 OR 108 Diameter of ports P, T: Ø 7,5 mm	Seals: 4 OR 108 Diameter of ports P, A, B, T: Ø 6,5 mm

18.2 AGMZA valves

	AGMZA-A-10	AGMZA-A-20	AGMZA-A-32
	Fastening bolts: 4 socket head screws M12x35 class 12.9 Tightening torque = 125 Nm	Fastening bolts: 4 socket head screws M16x50 class 12.9 Tightening torque = 300 Nm	Fastening bolts: 4 socket head screws M20x60 class 12.9 Tightening torque = 600 Nm
	Seals: 2 OR 123 Diameter of ports P, T: Ø 14 mm 1 OR 109/70 Diameter of port X: Ø 3,2 mm	Seals: 2 OR 4112 Diameter of ports P, T: Ø 24 mm 1 OR 109/70 Diameter of port X: Ø 3,2 mm	Seals: 2 OR 4131 Diameter of ports P, T: Ø 28 mm 1 OR 109/70 Diameter of port X: Ø 3,2 mm

RZMA-A-010

ISO 4401: 2005 (see table P005)
 Mounting surface: 4401-03-02-0-05
 (without ports A and B)

Mass [kg]	
RZMA-A-010	2,7
Option /O	+0,35

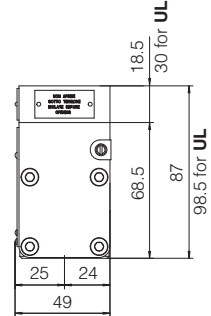
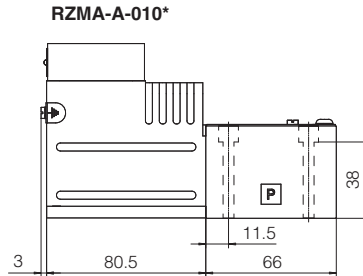
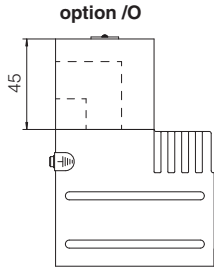

RZMA-A-030

ISO 4401: 2005 (see table P005)
 Mounting surface: 4401-03-02-0-05
 (ports A and B connected to port T)

Mass [kg]	
RZMA-A-030	3,7
Option /O	+0,35

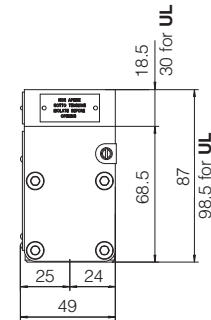
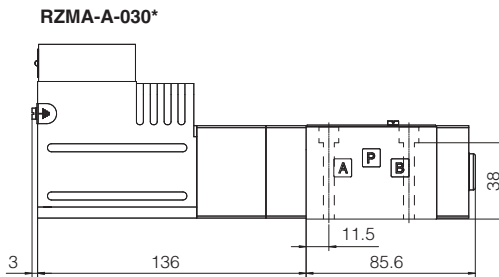
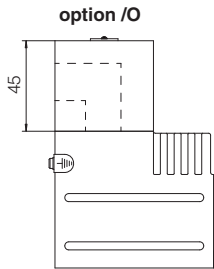

HZMA-A-030

ISO 4401: 2005 (see table P005)
 Mounting surface: 4401-03-02-0-05

Mass [kg]	
HZMA-A-030	3,7
Option /O	+0,35

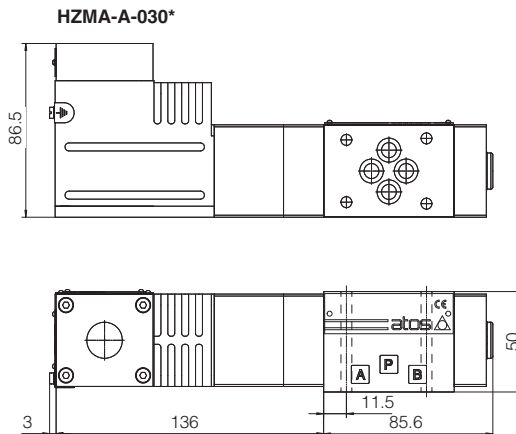
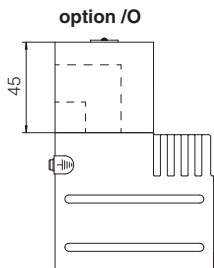

20 INSTALLATION DIMENSIONS FOR AGMZA [mm]

AGMZA-A-10

ISO 6264: 2007 (see table P005)
 Mounting surface: 6264-06-09-1-97

Mass [kg]	
AGMZA-A-10	6,3
Option /O	+0,35

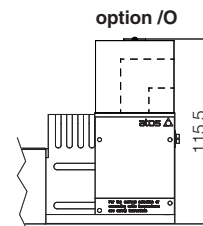
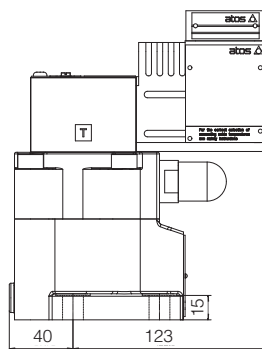
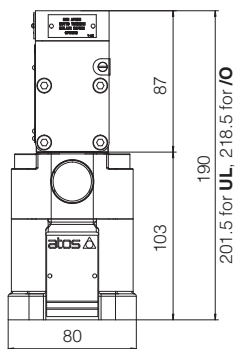

AGMZA-A-20

ISO 6264: 2007 (see table P005)
 Mounting surface: 6264-08-13-1-97

Mass [kg]	
AGMZA-A-20	7,5
Option /O	+0,35

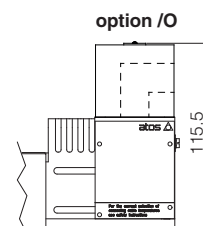
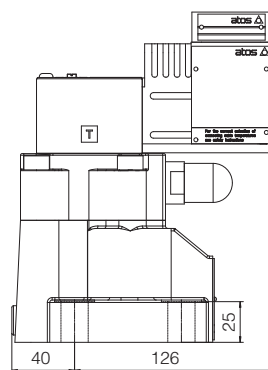
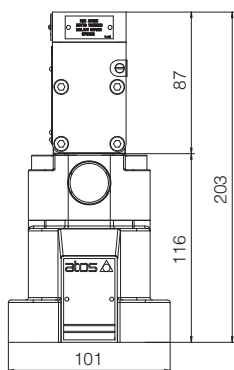

AGMZA-A-32

ISO 6264: 2007 (see table P005)
 Mounting surface: 6264-10-17-1-97
 (with M20 fixing holes instead of standard M18)

Mass [kg]	
AGMZA-A-32	8,9
Option /O	+0,35

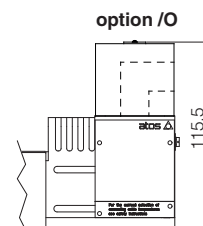
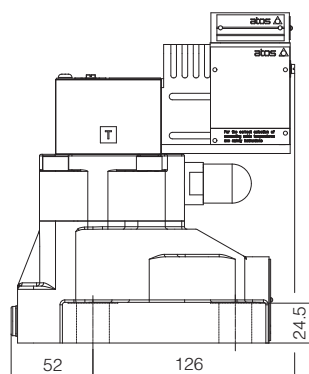
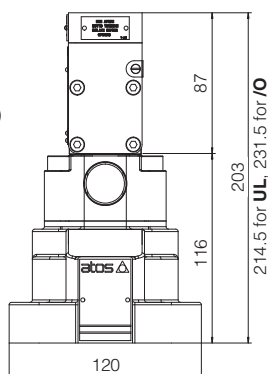

21 RELATED DOCUMENTATION

- X010** Basics for electrohydraulics in hazardous environments
- X020** Summary of Atos ex-proof components certified to ATEX, IECEx, EAC, PESO
- X030** Summary of Atos ex-proof components certified to cULus
- FX900** Operating and maintenance information for ex-proof proportional valves
- KX800** Cable glands for ex-proof valves
- P005** Mounting surfaces for electrohydraulic valves