

SIE200

"E" ECONOMY Series
Solenoid / Pneumatic Valves

- 5/2, 5/3
- 18mm Body Width
- Sub-Base or Manifold Mounting Type
- Transition Flow 700ℓ/min (5bar)

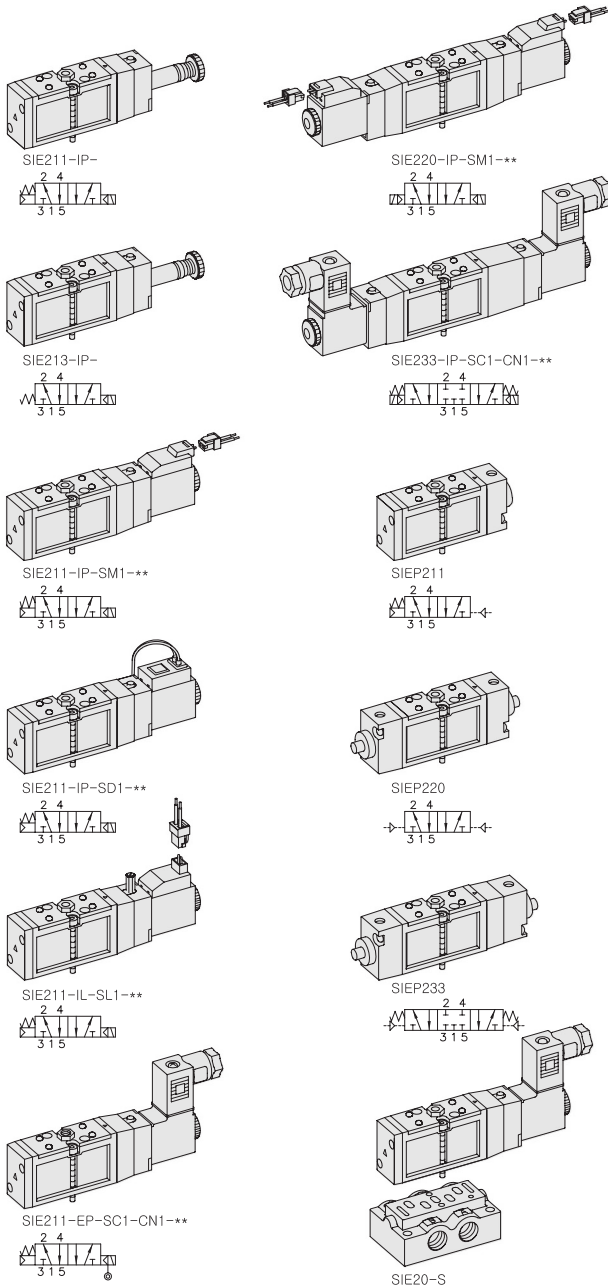

** : Voltage Selection (see page 80)

SPECIFICATION

ITEM	SERIES	SOLENOID, PNEUMATIC	
		5 Port 2 Position	5 Port 3 Position
Fluids		Compressed Air & Inert Gases	
Pressure(bar)		1.5~10.0	2.0~10.0
Eff. Sectional Area(mm ²)-5bar		12.0	8.5
Ambient & Fluid Temp.		5~60°C (41~140°F)	
Response Time(5bar)		25ms or Less	35ms or Less
Max. Working Frequency		5c/sec	3c/sec
Lubrication		Not Required(Use ISO VG32 #)	
Manual Override		Push Button(Standard), Lever Lock(Option)	
Coil Insulation Class		F-Class or Equivalent	
Permissible Voltage Variation		±10% of Rated Voltage	
Off Min. Residual Voltage		AC:20% or Less / DC:10% or Less	
Power Consumption		Holding-AC:3.5VA(60Hz) / DC:2.5W	

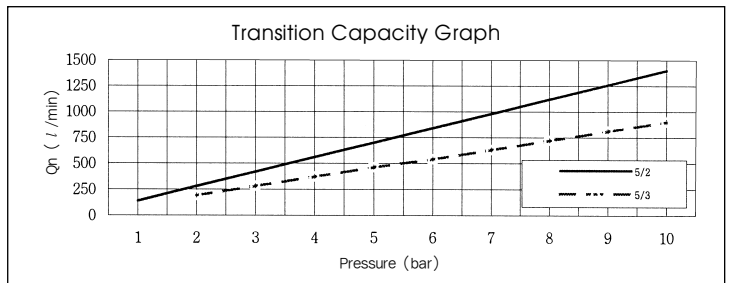

- ### The Material of Parts
- Valve Body : Die-Cast Aluminium
 - Spool : Aluminium
 - Seals : NBR
 - Spring : Stainless
 - Cap : Zinc Pressure Die-Cast
 - Pilot Parts : Glass Filled Nylon
 - Armature : Stainless Steel
 - Armature Seals : Viton

* The specification on each item can be amended without any prenotice to improve a performance.
* The specification on each item can be different from actual specification.

ORDERING NO.

SIE2 1 1 - I P - SC1 - CN1 - A2

Valve Series	Function	Return Method	Int/Ext. Pilot	Manual Operator	Solenoid Coil Type	Connector Type	Voltage
SIE2 : Solenoid Valve	1	5/2 Single	0 None	I Internal Pilot	0 None	0 None	0 None
	2	5/2 Double	1 Air + Spring	E External Pilot	P Push Non-Locking	CN1 Normal Connector	A2 AC 220V
	3	5/3 Closed Center	2 Air		L Lever Locking	SG1 Grommet/Flying Leads	A1 AC 110V
SIEP2 : Pneumatic Valve	4	5/3 Open Center	3 Spring		SD1 Grommet/Flying Leads With LED	CZ1 Connector With LED & Surge Suppressor	A4 AC 24V
	5	5/3 Pressure Center			SL1 90 Degree Plug-in Wire Assembly With LED		D4 DC 24V
					SM1 180 Degree Plug-in Wire Assembly With LED		D2 DC 12V

Solenoid & Pilot Actuated Spool Valves

18mm Body Width

5Port 2Position Solenoid Valve

Single Solenoid
SIE211-IP-SG1-***

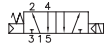

External Pilot
SIE211-EP-SG1-***

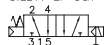

SIE211-IP-SM1-***

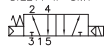

SIE211-IP-SC1-CN1-***

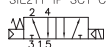

Double Solenoid
SIE220-IP-SL1-***

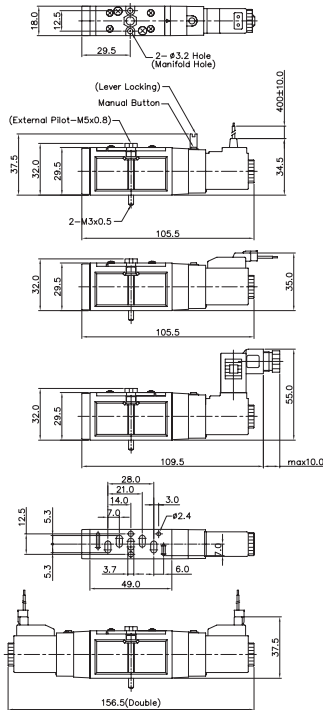
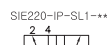

5Port 2Position Pneumatic Valve

Single Pneumatic
SIEP211

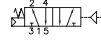

Double Pneumatic
SIEP220

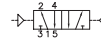

5Port 3Position Pneumatic Valve

Closed Center
SIEP233

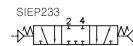

Exhaust Center
SIEP243

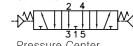

Pressure Center
SIEP253

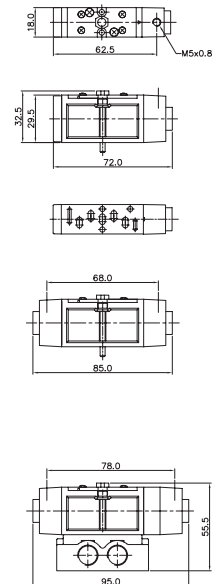
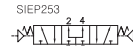

5Port 3Position Solenoid Valve

Closed Center
SIE233-IP-SC1-CN1-***

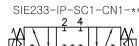

Exhaust Center
SIE243-IP-SC1-CN1-***

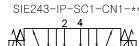

Pressure Center
SIE253-IP-SC1-CN1-***

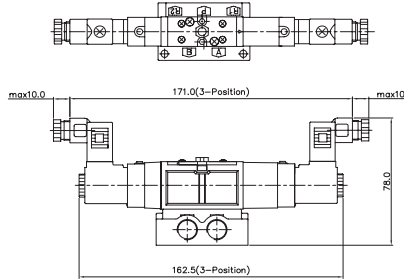
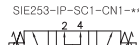

Sub Base Ordering Code

Sub Base Series	Port & Threaded	Function
SIB2	0 None	S Single Station Sub Base, 1/4 Port Without Pilot Ports
SIE200 Solenoid Valve	1 G	SP Single Station Sub Base, 1/4 Port With Pilot Ports
	2 NPT	DB Double Modular Sub Base, 1/8 Port Without Pilot Ports
		DC6 Double Modular Sub Base ϕ 6 One-Touch Fitting
		E End Cover, 1/8 Port
		EB End Blanking Cover

SIB20 SINGLE, DOUBLE SUB BASE

(SIE200 Solenoid & Pneumatic Valve Use Sub Base)

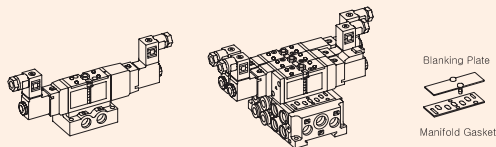

Single Station Sub Base Dimension

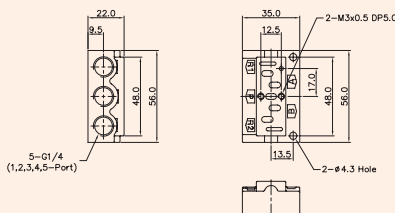

Double Modular Sub Base Dimension

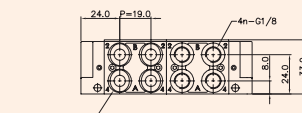
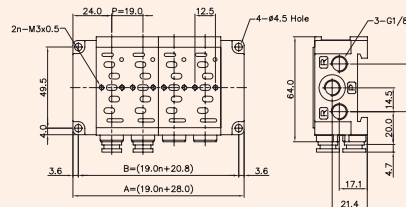

DOUBLE MODULAR SUB BASE DIMENSION	n-STATION				
ITEM	2	4	6	8	10
B	58.8	96.8	134.8	172.8	210.8
A	66.0	104.0	142.0	180.0	218.0

Ordering Code SIB20-BLK	Blanking Plate (Material: STS304)
	Manifold Gasket. (Material: NBR)
Ordering Code SIB21-E	End Cover, 1/8 (Material: AI)
Ordering Code SIB20-EB	End Blanking Cover (Material: AI)
Ordering Code SIB21-DB	Double Modular Sub Base, 1/8 (Material: AI)
Ordering Code SIB20-DC6	Double Modular Sub Base ϕ 6 one-touch fitting (Material: AI)